

SLIGHT

POWERGEAR CATALOGUE

2025

slightly different



Slight®
slightly different

3-CIRCUIT TRACK SYSTEM	08
3-CIRCUIT DALI TRACK SYSTEM	18
1-CIRCUIT DALI TRACK SYSTEM	26
TRACK SUSPENSION & GENERAL ACCESSORIES	32
ADAPTERS & ULTIMATE ADAPTERS	40
48V TRACK SYSTEM	54
TECHNICAL DETAILS	76



Cost effective

Flexible Solutions



High
quality
standards

Innovative



Maximum freedom to create your ultimate trackplan





3-CIRCUIT TRACK SYSTEM

Powergear's high quality 3-circuit track system for the professional lighting market is suitable for track lights with 3-circuit adapters of all major brands.

A comprehensive range of innovative accessories give designers maximum freedom to create unique track plans. For both surface mounted and recessed 3-circuit track the same accessories can be used. The unique Powergear Twisted L and T connectors enable a quick and easy installation with less items to take care of.

Powergear track can be easily shortened and is immediately ready to install as there is no need to adjust wires. The "EZCLICK" mounting features make the track system quick and easy to install.

A new, innovative and competitive range of Powergear Ultimate adapters is at your disposal. As the LED driver is concealed in the adapter you can continue to miniaturize your track lights.

To make your 3-circuit system Bluetooth controllable, Powergear offers Ultimate adapters with Casambi technology.

3-CIRCUIT TRACK SYSTEM

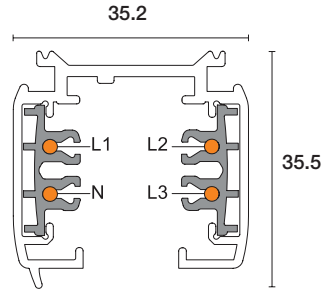
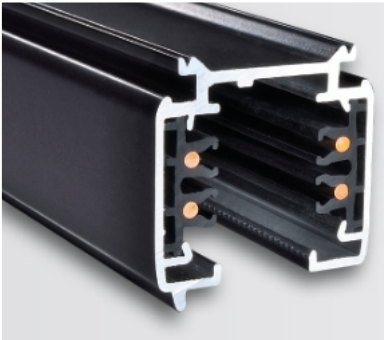

SURFACE MOUNTED

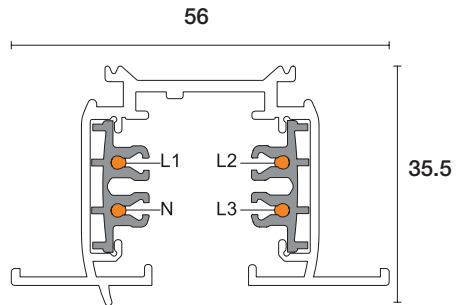
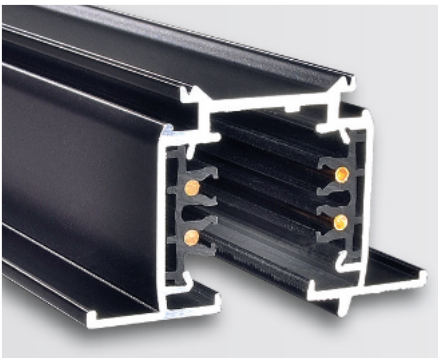

RECESSED

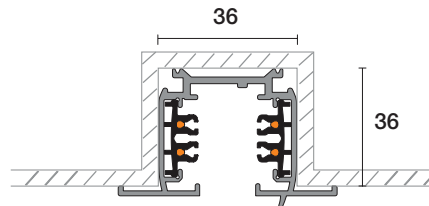

More technical details on page 40.

3-CIRCUIT SURFACE MOUNTED TRACK SYSTEM

Product Code	EAN	Product description	Colour	Package
PRO-0410-W	8719747930007	1 M track (1000mm)	☐ White	1 / 6
PRO-0410-S	8719747930014	1 M track (1000mm)	■ Grey	1 / 6
PRO-0410-B	8719747930021	1 M track (1000mm)	■ Black	1 / 6
PRO-0420-W	8719747930069	2 M track (2000mm)	☐ White	1 / 6
PRO-0420-S	8719747930076	2 M track (2000mm)	■ Grey	1 / 6
PRO-0420-B	8719747930083	2 M track (2000mm)	■ Black	1 / 6
PRO-0430-W	8719747930120	3 M track (3000mm)	☐ White	1 / 6
PRO-0430-S	8719747930137	3 M track (3000mm)	■ Grey	1 / 6
PRO-0430-B	8719747930144	3 M track (3000mm)	■ Black	1 / 6
PRO-04400-W	8719747933275	4 M track (4000mm)	☐ White	1 / 6
PRO-04400-S	8719747933282	4 M track (4000mm)	■ Grey	1 / 6
PRO-04400-B	8719747933299	4 M track (4000mm)	■ Black	1 / 6

3-CIRCUIT RECESSED TRACK SYSTEM

Product Code	EAN	Product description	Colour	Package
PRO-R410-W	8719747931011	1 M track (1000mm)	☐ White	1 / 4
PRO-R410-S	8719747931028	1 M track (1000mm)	■ Grey	1 / 4
PRO-R410-B	8719747931035	1 M track (1000mm)	■ Black	1 / 4
PRO-R420-W	8719747931042	2 M track (2000mm)	☐ White	1 / 4
PRO-R420-S	8719747931059	2 M track (2000mm)	■ Grey	1 / 4
PRO-R420-B	8719747931066	2 M track (2000mm)	■ Black	1 / 4
PRO-R430-W	8719747931073	3 M track (3000mm)	☐ White	1 / 4
PRO-R430-S	8719747931080	3 M track (3000mm)	■ Grey	1 / 4
PRO-R430-B	8719747931097	3 M track (3000mm)	■ Black	1 / 4
PRO-R4400-W	8719747933428	4 M track (4000mm)	☐ White	1 / 4
PRO-R4400-S	8719747933435	4 M track (4000mm)	■ Grey	1 / 4
PRO-R4400-B	8719747933442	4 M track (4000mm)	■ Black	1 / 4

CONNECTION PARTS 3-CIRCUIT TRACK SYSTEM

CONNECTOR LEFT



Product Code	EAN	Colour	Package
PRO-0431 L-W	8719747930212	White	12 / 144
PRO-0431 L-S	8719747930229	Grey	12 / 144
PRO-0431 L-B	8719747930236	Black	12 / 144



CONNECTOR RIGHT



Product Code	EAN	Colour	Package
PRO-0431 R-W	8719747930243	White	12 / 144
PRO-0431 R-S	8719747930250	Grey	12 / 144
PRO-0431 R-B	8719747930267	Black	12 / 144



COUPLER (INSULATION)

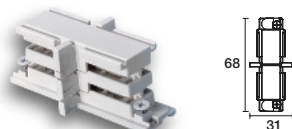

Product Code	EAN	Colour	Package
PRO-0433A-W	8719747930335	White	8 / 160
PRO-0433A-S	8719747930342	Grey	8 / 160
PRO-0433A-B	8719747930359	Black	8 / 160



MIDDLE CONNECTOR



Product Code	EAN	Colour	Package
PRO-0434-W	8719747930366	White	10 / 120
PRO-0434-S	8719747930373	Grey	10 / 120
PRO-0434-B	8719747930380	Black	10 / 120



FLEXIBLE CONNECTOR



Product Code	EAN	Colour	Package
PRO-0439-W	8719747930601	White	14 / 70
PRO-0439-S	8719747930618	Grey	14 / 70
PRO-0439-B	8719747930625	Black	14 / 70



ADJUSTABLE CONNECTOR



Product Code	EAN	Colour	Package
PRO-M435-W	8719747930632	White	15 / 90
PRO-M435-S	8719747930649	Grey	15 / 90
PRO-M435-B	8719747930656	Black	15 / 90



COUPLER

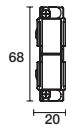

Product Code	EAN	Colour	Package
PRO-0433-W	8719747930304	White	10 / 200
PRO-0433-S	8719747930311	Grey	10 / 200
PRO-0433-B	8719747930328	Black	10 / 200



END CAP



Product Code	EAN	Colour	Package
PRO-0432-W	8719747930274	White	24 / 288
PRO-0432-S	8719747930281	Grey	24 / 288
PRO-0432-B	8719747930298	Black	24 / 288



X CONNECTOR

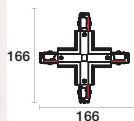

Product Code	EAN	Colour	Package
PRO-0437-W	8719747930571	White	5 / 60
PRO-0437-S	8719747930588	Grey	5 / 60
PRO-0437-B	8719747930595	Black	5 / 60



TWISTED T AND L CONNECTORS

Powergear Twisted T (and L) connectors enable maximum flexibility to create the ultimate trackplan with less connectors to use, and provide the installer with maximum freedom to make adjustments at the building site.

Simply unscrew the cover plate and change L1 into L2 or R1 into R2. Powergear's twisted connectors can also be used to power the track.

TWISTED T CONNECTOR

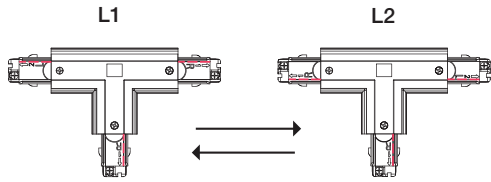
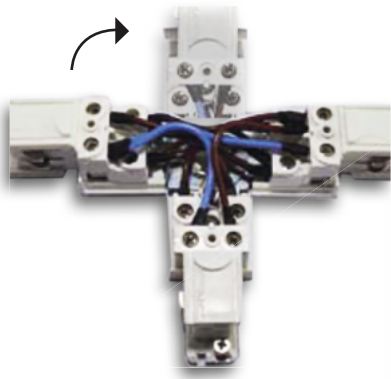

L1 can be changed into L2

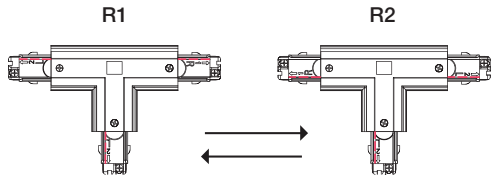

R1 can be changed into R2

TWISTED L CONNECTOR

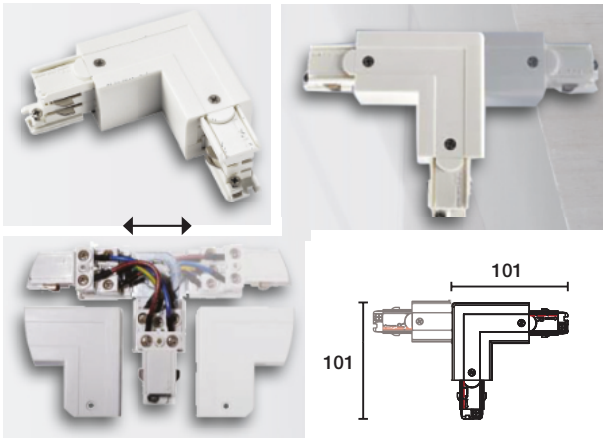

TWISTED L CONNECTOR (L AND R)

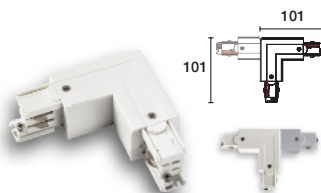

Product Code	EAN	Colour	Package
PRO-M438-W	8719747930663	White	18 / 108
PRO-M438-S	8719747930670	Grey	18 / 108
PRO-M438-B	8719747930687	Black	18 / 108



TWISTED T CONNECTOR L1 -> L2

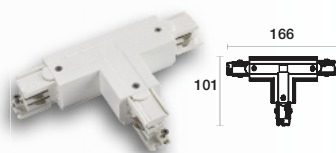

Product Code	EAN	Colour	Package
PRO-M436L-W	8719747930694	White	12 / 72
PRO-M436L-S	8719747930700	Grey	12 / 72
PRO-M436L-B	8719747930717	Black	12 / 72



TWISTED T CONNECTOR R1 -> R2

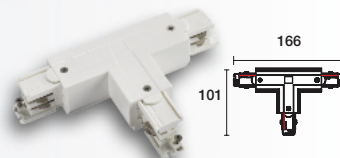

Product Code	EAN	Colour	Package
PRO-M436R-W	871974790724	White	12 / 72
PRO-M436R-S	871974790731	Grey	12 / 72
PRO-M436R-B	871974790748	Black	12 / 72



L CONNECTOR LEFT

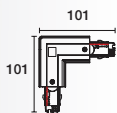

Product Code	EAN	Colour	Package
PRO-0435 L-W	8719747930397	White	18 / 108
PRO-0435 L-S	8719747930403	Grey	18 / 108
PRO-0435 L-B	8719747930410	Black	18 / 108



L CONNECTOR RIGHT

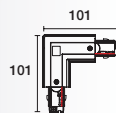

Product Code	EAN	Colour	Package
PRO-0435 R-W	8719747930427	White	8 / 160
PRO-0435 R-S	8719747930434	Grey	8 / 160
PRO-0435 R-B	8719747930441	Black	8 / 160



T CONNECTOR RIGHT1

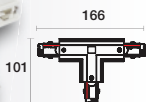

Product Code	EAN	Colour	Package
PRO-0436 R1-W	8719747930519	White	12 / 72
PRO-0436 R1-S	8719747930526	Grey	12 / 72
PRO-0436 R1-B	8719747930533	Black	12 / 72



T CONNECTOR RIGHT2

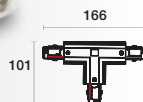

Product Code	EAN	Colour	Package
PRO-0436 R2-W	8719747930540	White	12 / 72
PRO-0436 R2-S	8719747930557	Grey	12 / 72
PRO-0436 R2-B	8719747930564	Black	12 / 72



MIDDLE CONNECTOR RECESSED COVER

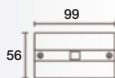

Product Code	EAN	Colour	Package
PRO-RX434-W	8719747935811	White	24 / 144
PRO-RX434-S	8719747935828	Grey	24 / 144
PRO-RX434-B	8719747935835	Black	24 / 144



L CONNECTOR RECESSED COVER



Product Code	EAN	Colour	Package
PRO-RX435-W	8719747935842	White	18 / 90
PRO-RX435-S	8719747935859	Grey	18 / 90
PRO-RX435-B	8719747935613	Black	18 / 90



T CONNECTOR LEFT1

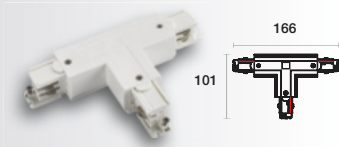

Product Code	EAN	Colour	Package
PRO-0436 L1-W	8719747930458	White	12 / 72
PRO-0436 L1-S	8719747930465	Grey	12 / 72
PRO-0436 L1-B	8719747930472	Black	12 / 72



T CONNECTOR LEFT2

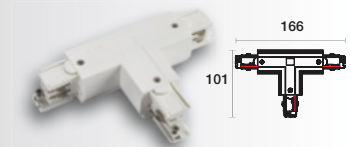

Product Code	EAN	Colour	Package
PRO-0436 L2-W	8719747930489	White	12 / 72
PRO-0436 L2-S	8719747930496	Grey	12 / 72
PRO-0436 L2-B	8719747930502	Black	12 / 72



RECESSED END CAP

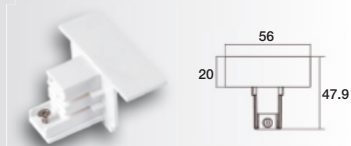

Product Code	EAN	Colour	Package
PRO-RX432-W	8719747934678	White	15 / 300
PRO-RX432-S	8719747934685	Grey	15 / 300
PRO-RX432-B	8719747934692	Black	15 / 300



X CONNECTOR RECESSED COVER



Product Code	EAN	Colour	Package
PRO-RX437-W	8719747935781	White	16 / 96
PRO-RX437-S	8719747935798	Grey	16 / 96
PRO-RX437-B	8719747935804	Black	16 / 96



CONNECTOR RECESSED COVER



Product Code	EAN	Colour	Package
PRO-RX431-W	8719747935576	White	8 / 96
PRO-RX431-S	8719747935774	Grey	8 / 96
PRO-RX431-B	8719747935606	Black	8 / 96



T CONNECTOR RECESSED COVER



Product Code	EAN	Colour	Package
PRO-RX436-W	8719747935866	White	16 / 96
PRO-RX436-S	8719747935873	Grey	16 / 96
PRO-RX436-B	8719747935880	Black	16 / 96



Make your Powergear lighting track
a smart DALI system



SMART 3-CIRCUIT DALI TRACK SYSTEM

Powergear's high quality DALI 3-circuit track system for the professional lighting market is suitable for track lights with Powergear 3-circuit DALI adapters.

A comprehensive range of innovative DALI accessories give designers maximum freedom to create unique and smart track plans. The DALI accessories can be used for both surface mounted and recessed 3-phase DALI track.

Powergear DALI track can be easily shortened and is immediately ready to install as there is no need to adjust wires. The "EZCLICK" mounting features make the track system quick and easy to install.

A new, innovative and competitive range of Powergear Ultimate DALI adapters is at your disposal. As the DALI LED driver is concealed in the adapter you can continue to miniaturize your track lights.



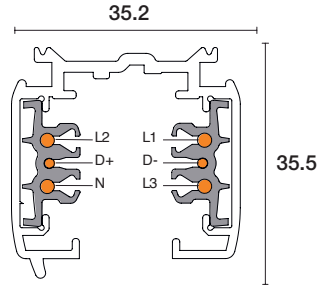
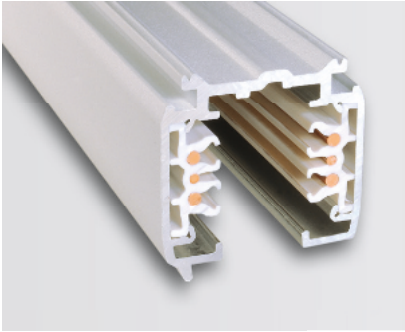

SURFACE MOUNTED

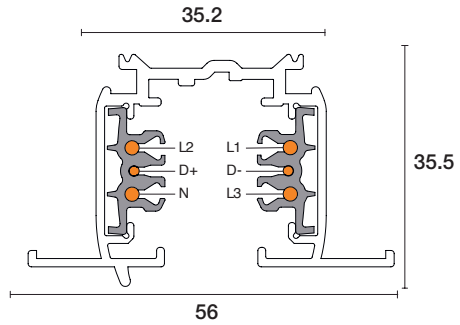

RECESSED

More technical details on page 41.

3-CIRCUIT DALI SURFACE MOUNTED TRACK SYSTEM

Product Code	EAN	Product description	Colour	Package
PRO-0610-W	8719747931257	1 M DALI track (1000mm)	<input type="checkbox"/> White	1 / 6
PRO-0610-S	8719747931264	1 M DALI track (1000mm)	<input checked="" type="checkbox"/> Grey	1 / 6
PRO-0610-B	8719747931271	1 M DALI track (1000mm)	<input checked="" type="checkbox"/> Black	1 / 6
PRO-0620-W	8719747931288	2 M DALI track (2000mm)	<input type="checkbox"/> White	1 / 6
PRO-0620-S	8719747931295	2 M DALI track (2000mm)	<input checked="" type="checkbox"/> Grey	1 / 6
PRO-0620-B	8719747931301	2 M DALI track (2000mm)	<input checked="" type="checkbox"/> Black	1 / 6
PRO-0630-W	8719747931318	3 M DALI track (3000mm)	<input type="checkbox"/> White	1 / 6
PRO-0630-S	8719747931325	3 M DALI track (3000mm)	<input checked="" type="checkbox"/> Grey	1 / 6
PRO-0630-B	8719747931332	3 M DALI track (3000mm)	<input checked="" type="checkbox"/> Black	1 / 6
PRO-06400-W	8719747933459	4 M DALI track (4000mm)	<input type="checkbox"/> White	1 / 6
PRO-06400-S	8719747933466	4 M DALI track (4000mm)	<input checked="" type="checkbox"/> Grey	1 / 6
PRO-06400-B	8719747933473	4 M DALI track (4000mm)	<input checked="" type="checkbox"/> Black	1 / 6

3-CIRCUIT DALI RECESSED TRACK SYSTEM

Product Code	EAN	Product description	Colour	Package
PRO-R610-W	8719747931738	1 M DALI track (1000mm)	<input type="checkbox"/> White	1 / 4
PRO-R610-S	8719747931745	1 M DALI track (1000mm)	<input checked="" type="checkbox"/> Grey	1 / 4
PRO-R610-B	8719747931752	1 M DALI track (1000mm)	<input checked="" type="checkbox"/> Black	1 / 4
PRO-R620-W	8719747931769	2 M DALI track (2000mm)	<input type="checkbox"/> White	1 / 4
PRO-R620-S	8719747931776	2 M DALI track (2000mm)	<input checked="" type="checkbox"/> Grey	1 / 4
PRO-R620-B	8719747931783	2 M DALI track (2000mm)	<input checked="" type="checkbox"/> Black	1 / 4
PRO-R630-W	8719747931790	3 M DALI track (3000mm)	<input type="checkbox"/> White	1 / 4
PRO-R630-S	8719747931806	3 M DALI track (3000mm)	<input checked="" type="checkbox"/> Grey	1 / 4
PRO-R630-B	8719747931813	3 M DALI track (3000mm)	<input checked="" type="checkbox"/> Black	1 / 4
PRO-R6400-W	8719747933480	4 M DALI track (4000mm)	<input type="checkbox"/> White	1 / 4
PRO-R6400-S	8719747933497	4 M DALI track (4000mm)	<input checked="" type="checkbox"/> Grey	1 / 4
PRO-R6400-B	8719747933503	4 M DALI track (4000mm)	<input checked="" type="checkbox"/> Black	1 / 4

CONNECTOR LEFT DALI 3-CIRCUIT



Product Code	EAN	Colour	Package
PRO-D631 L-W	8719747931370	White	10 / 120
PRO-D631 L-S	8719747931387	Grey	10 / 120
PRO-D631 L-B	8719747931394	Black	10 / 120



CONNECTOR RIGHT DALI 3-CIRCUIT



Product Code	EAN	Colour	Package
PRO-D631 R-W	8719747931400	White	10 / 120
PRO-D631 R-S	8719747931417	Grey	10 / 120
PRO-D631 R-B	8719747931424	Black	10 / 120



MIDDLE CONNECTOR DALI 3-CIRCUIT



Product Code	EAN	Colour	Package
PRO-D634-W	8719747931462	White	10 / 120
PRO-D634-S	8719747931479	Grey	10 / 120
PRO-D634-B	8719747931486	Black	10 / 120



END CAP



Product Code	EAN	Colour	Package
PRO-0432-W	8719747930274	White	15 / 300
PRO-0432-S	8719747930281	Grey	15 / 300
PRO-0432-B	8719747930298	Black	15 / 300



X CONNECTOR DALI 3-CIRCUIT

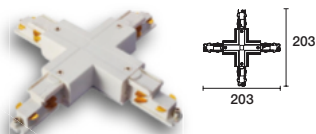

Product Code	EAN	Colour	Package
PRO-D637-W	8719747931585	White	2 / 24
PRO-D637-S	8719747931592	Grey	2 / 24
PRO-D637-B	8719747931608	Black	2 / 24



L CONNECTOR DALI LEFT 3-CIRCUIT



Product Code	EAN	Colour	Package
PRO-D635 L-W	8719747931493	White	12 / 60
PRO-D635 L-S	8719747931509	Grey	12 / 60
PRO-D635 L-B	8719747931516	Black	12 / 60



COUPLER DALI 3-CIRCUIT

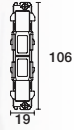

Product Code	EAN	Colour	Package
PRO-D633-W	8719747931431	White	10 / 180
PRO-D633-S	8719747931448	Grey	10 / 180
PRO-D633-B	8719747931455	Black	10 / 180



FLEXIBLE CONNECTOR DALI 3-CIRCUIT



Product Code	EAN	Colour	Package
PRO-D639-W	8719747931554	White	12 / 60
PRO-D639-S	8719747931561	Grey	12 / 60
PRO-D639-B	8719747931578	Black	12 / 60



L CONNECTOR DALI RIGHT 3-CIRCUIT

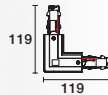

Product Code	EAN	Colour	Package
PRO-D635 R-W	8719747931523	White	12 / 60
PRO-D635 R-S	8719747931530	Grey	12 / 60
PRO-D635 R-B	8719747931547	Black	12 / 60



T CONNECTOR DALI LEFT1 3-CIRCUIT



Product Code	EAN	Colour	Package
PRO-D636 L1-W	8719747931646	White	9 / 54
PRO-D636 L1-S	8719747931653	Grey	9 / 54
PRO-D636 L1-B	8719747931660	Black	9 / 54



T CONNECTOR DALI LEFT2 3-CIRCUIT



Product Code	EAN	Colour	Package
PRO-D636 L2-W	8719747931677	White	9 / 54
PRO-D636 L2-S	8719747931684	Grey	9 / 54
PRO-D636 L2-B	8719747931691	Black	9 / 54



RECESSED END CAP

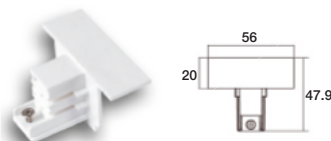

Product Code	EAN	Colour	Package
PRO-RX432-W	8719747934678	White	24 / 288
PRO-RX432-S	8719747934685	Grey	24 / 288
PRO-RX432-B	8719747934692	Black	24 / 288



CONNECTOR RECESSED COVER



Product Code	EAN	Colour	Package
PRO-RX631-W	8719747935897	White	18 / 108
PRO-RX631-S	8719747935903	Grey	18 / 108
PRO-RX631-B	8719747935910	Black	18 / 108



X CONNECTOR RECESSED COVER



Product Code	EAN	Colour	Package
PRO-RX437-W	8719747935781	White	16 / 96
PRO-RX437-S	8719747935798	Grey	16 / 96
PRO-RX437-B	8719747935804	Black	16 / 96



MIDDLE CONNECTOR RECESSED COVER



Product Code	EAN	Colour	Package
PRO-RX434-W	8719747935811	White	24 / 144
PRO-RX434-S	8719747935828	Grey	24 / 144
PRO-RX434-B	8719747935835	Black	24 / 144



T CONNECTOR DALI RIGHT1 3-CIRCUIT



Product Code	EAN	Colour	Package
PRO-D636 R1-W	8719747931707	White	9 / 54
PRO-D636 R1-S	8719747931714	Grey	9 / 54
PRO-D636 R1-B	8719747931721	Black	9 / 54



T CONNECTOR DALI RIGHT2 3-CIRCUIT



Product Code	EAN	Colour	Package
PRO-D636 R2-W	8719747931615	White	9 / 54
PRO-D636 R2-S	8719747931622	Grey	9 / 54
PRO-D636 R2-B	8719747931639	Black	9 / 54



T CONNECTOR RECESSED COVER



Product Code	EAN	Colour	Package
PRO-RX436-W	8719747935866	White	16 / 96
PRO-RX436-S	8719747935873	Grey	16 / 96
PRO-RX436-B	8719747935880	Black	16 / 96



L CONNECTOR RECESSED COVER



Product Code	EAN	Colour	Package
PRO-RX435-W	8719747935842	White	18 / 90
PRO-RX435-S	8719747935859	Grey	18 / 90
PRO-RX435-B	8719747935613	Black	18 / 90



Create your own DALI system
with standard 3-circuit track





1-CIRCUIT DALI TRACK SYSTEM

Powergear 1-circuit DALI solutions helps customers to create their own DALI solution with a standard 3-circuit track.

Highly suitable when the track is not too comprehensive and the budget is limited.

Simply apply the comprehensive range of innovative DALI 1-circuit accessories and a standard track is turned into a DALI version.

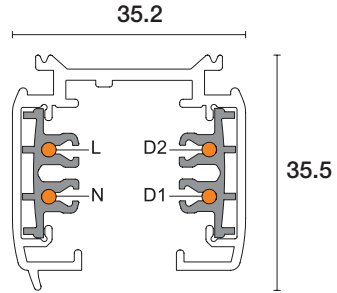
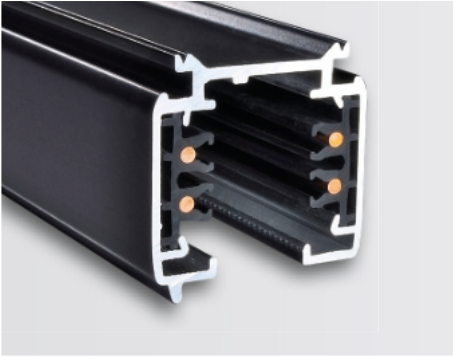

SURFACE MOUNTED

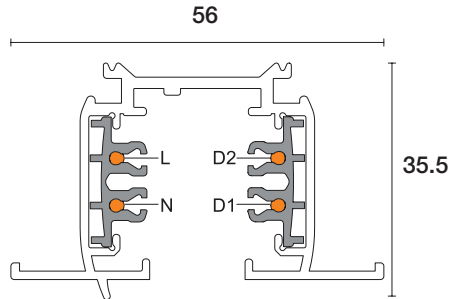
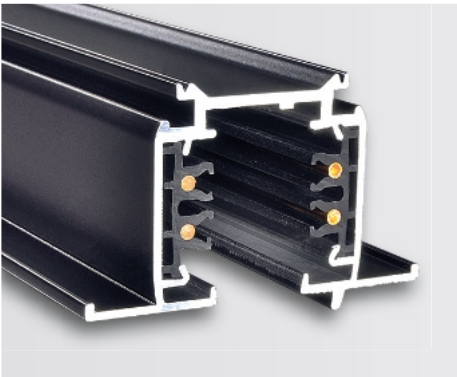

RECESSED

More technical details on page 42.

Simply apply the comprehensive range of innovative DALI 1-circuit accessories and a standard track is turned into a DALI version.

3-CIRCUIT SURFACE MOUNTED TRACK SYSTEM

Product Code	EAN	Product description	Colour	Package
PRO-0410-W	8719747930007	1 M track (1000mm)	☐ White	1 / 6
PRO-0410-S	8719747930014	1 M track (1000mm)	■ Grey	1 / 6
PRO-0410-B	8719747930021	1 M track (1000mm)	■ Black	1 / 6
PRO-0420-W	8719747930069	2 M track (2000mm)	☐ White	1 / 6
PRO-0420-S	8719747930076	2 M track (2000mm)	■ Grey	1 / 6
PRO-0420-B	8719747930083	2 M track (2000mm)	■ Black	1 / 6
PRO-0430-W	8719747930120	3 M track (3000mm)	☐ White	1 / 6
PRO-0430-S	8719747930137	3 M track (3000mm)	■ Grey	1 / 6
PRO-0430-B	8719747930144	3 M track (3000mm)	■ Black	1 / 6
PRO-04400-W	8719747933275	4 M track (4000mm)	☐ White	1 / 6
PRO-04400-S	8719747933282	4 M track (4000mm)	■ Grey	1 / 6
PRO-04400-B	8719747933299	4 M track (4000mm)	■ Black	1 / 6

3-CIRCUIT RECESSED TRACK SYSTEM

Product Code	EAN	Product description	Colour	Package
PRO-R410-W	8719747931011	1 M track (1000mm)	☐ White	1 / 4
PRO-R410-S	8719747931028	1 M track (1000mm)	■ Grey	1 / 4
PRO-R410-B	8719747931035	1 M track (1000mm)	■ Black	1 / 4
PRO-R420-W	8719747931042	2 M track (2000mm)	☐ White	1 / 4
PRO-R420-S	8719747931059	2 M track (2000mm)	■ Grey	1 / 4
PRO-R420-B	8719747931066	2 M track (2000mm)	■ Black	1 / 4
PRO-R430-W	8719747931073	3 M track (3000mm)	☐ White	1 / 4
PRO-R430-S	8719747931080	3 M track (3000mm)	■ Grey	1 / 4
PRO-R430-B	8719747931097	3 M track (3000mm)	■ Black	1 / 4
PRO-R4400-W	8719747933428	4 M track (4000mm)	☐ White	1 / 4
PRO-R4400-S	8719747933435	4 M track (4000mm)	■ Grey	1 / 4
PRO-R4400-B	8719747933442	4 M track (4000mm)	■ Black	1 / 4

COUPLER, ENDCAP AND CONNECTOR COVER ARE THE SAME AS FOR STANDARD 3-CIRCUIT TRACK

CONNECTOR LEFT DALI 1-CIRCUIT



Product Code	EAN	Colour	Package
PRO-D431 L-W	8719747931882	White	12 / 144
PRO-D431 L-S	8719747931899	Grey	12 / 144
PRO-D431 L-B	8719747931905	Black	12 / 144



CONNECTOR RIGHT DALI 1-CIRCUIT



Product Code	EAN	Colour	Package
PRO-D431 R-W	8719747931912	White	12 / 144
PRO-D431 R-S	8719747931929	Grey	12 / 144
PRO-D431 R-B	8719747931936	Black	12 / 144



FLEXIBLE CONNECTOR DALI 1-CIRCUIT



Product Code	EAN	Colour	Package
PRO-D439-W	8719747932247	White	14 / 70
PRO-D439-S	8719747932254	Grey	14 / 70
PRO-D439-B	8719747932261	Black	14 / 70



X CONNECTOR DALI 1-CIRCUIT

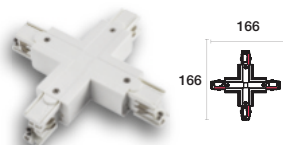

Product Code	EAN	Colour	Package
PRO-D437-W	8719747932216	White	5 / 60
PRO-D437-S	8719747932223	Grey	5 / 60
PRO-D437-B	8719747932230	Black	5 / 60



T CONNECTOR DALI LEFT 1-CIRCUIT

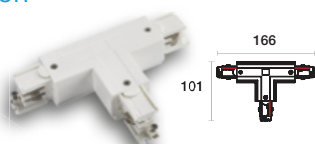

Product Code	EAN	Colour	Package
PRO-D436 L1-W	8719747932094	White	12 / 72
PRO-D436 L1-S	8719747932100	Grey	12 / 72
PRO-D436 L1-B	8719747932117	Black	12 / 72



T CONNECTOR DALI LEFT 2 1-CIRCUIT

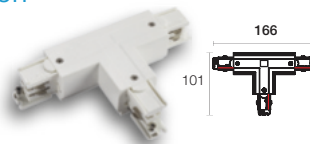

Product Code	EAN	Colour	Package
PRO-D436 L2-W	8719747932124	White	12 / 72
PRO-D436 L2-S	8719747932131	Grey	12 / 72
PRO-D436 L2-B	8719747932148	Black	12 / 72



MIDDLE CONNECTOR DALI 1-CIRCUIT

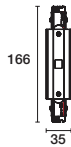

Product Code	EAN	Colour	Package
PRO-D434-W	8719747932001	□ White	10 / 120
PRO-D434-S	8719747932018	■ Grey	10 / 120
PRO-D434-B	8719747932025	■ Black	10 / 120



L CONNECTOR DALI LEFT 1-CIRCUIT

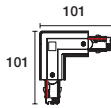

Product Code	EAN	Colour	Package
PRO-D435 L-W	8719747932032	□ White	18 / 108
PRO-D435 L-S	8719747932049	■ Grey	18 / 108
PRO-D435 L-B	8719747932056	■ Black	18 / 108



L CONNECTOR DALI RIGHT 1-CIRCUIT

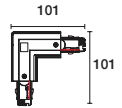

Product Code	EAN	Colour	Package
PRO-D435 R-W	8719747932063	□ White	18 / 108
PRO-D435 R-S	8719747932070	■ Grey	18 / 108
PRO-D435 R-B	8719747932087	■ Black	18 / 108



T CONNECTOR DALI RIGHT1 1-CIRCUIT

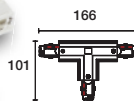

Product Code	EAN	Colour	Package
PRO-D436 R1-W	8719747932155	□ White	12 / 72
PRO-D436 R1-S	8719747932162	■ Grey	12 / 72
PRO-D436 R1-B	8719747932179	■ Black	12 / 72



T CONNECTOR DALI RIGHT2 1-CIRCUIT

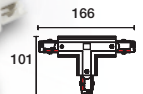

Product Code	EAN	Colour	Package
PRO-D436 R2-W	8719747932186	□ White	12 / 72
PRO-D436 R2-S	8719747932193	■ Grey	12 / 72
PRO-D436 R2-B	8719747932209	■ Black	12 / 72





Track system design made flexible and versatile

TRACK SUSPENSION & GENERAL ACCESSORIES

The Powergear track suspension accessories make the track system quick and easy to install. Suspension kits wire lengths can be customized. Track plans can be easily extended via fixed or DALI monopoints. And for an additional power outlet simply use the Powergear Schuko adapter.



SUSPENSION CONNECTION CLAMP

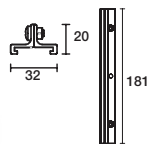

Product Code	EAN	Colour	Package
PRO-0418SK-W	8719747930847	White	6 / 180
PRO-0418SK-S	8719747930854	Grey	6 / 180
PRO-0418SK-B	8719747930861	Black	6 / 180



ROD SUSPENSION EZCLICK

suspension kit with 1m rod

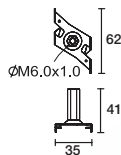

Product Code	EAN	Colour	Package
PRO-EZ0447-W	8719747930755	White	1 / 30
PRO-EZ0447-S	8719747930762	Grey	1 / 30
PRO-EZ0447-B	8719747930779	Black	1 / 30



WIRE SUSPENSION EZCLICK 5M

suspension kit with 5m steel wire

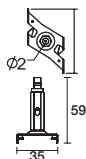

Product Code	EAN	Colour	Package
PRO-EZ0448-W	8719747930786	White	8 / 96
PRO-EZ0448-S	8719747930793	Grey	8 / 96
PRO-EZ0448-B	8719747930809	Black	8 / 96



T-BAR EZCLICK

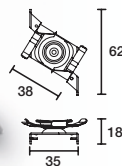
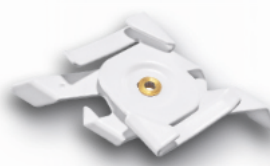

Product Code	EAN	Colour	Package
PRO-M146T-W	8719747930816	White	25 / 500
PRO-M146T-S	8719747930823	Grey	25 / 500
PRO-M146T-B	8719747930830	Black	25 / 500



MOUNTING CLAMP

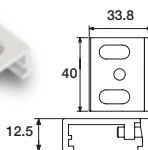

Product Code	EAN	Colour	Package
PRO-04SK-W	8719747930939	White	30 / 600
PRO-04SK-S	8719747930946	Grey	30 / 600
PRO-04SK-B	8719747930953	Black	30 / 600



SUSPENSION HOOK

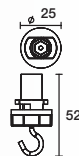

Product Code	EAN	Colour	Package
PRO-M142-W	8719747930878	White	20 / 400
PRO-M142-S	8719747930885	Grey	20 / 400
PRO-M142-B	8719747930892	Black	20 / 400



WIRE SUSPENSION EZCLICK 5M

suspension kit with 5m steel wire

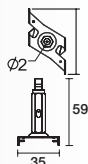

Product Code	EAN	Colour	Package
PRO-EZ0449-W	8719747932483	White	8 / 96
PRO-EZ0449-S	8719747932490	Grey	8 / 96
PRO-EZ0449-B	8719747932506	Black	8 / 96



SUSPENSION CLAMP FORTRACK

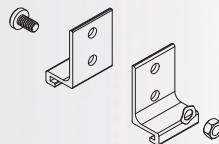

Product Code	EAN	Colour	Package
PRO-0416SK-W	8719747934722	White	15 / 300
PRO-0416SK-S	8719747934739	Grey	15 / 300
PRO-0416SK-B	8719747934289	Black	15 / 300



REINFORCEMENT PLATE

reinforcement plate with 5m steel suspension wire

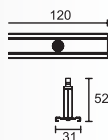

Product Code	EAN	Colour	Package
PRO-M147-W	8719747932643	White	4 / 48
PRO-M147-S	8719747932650	Grey	4 / 48
PRO-M147-B	8719747932667	Black	4 / 48



FIXING BRACKET FOR RECESSED TRACK

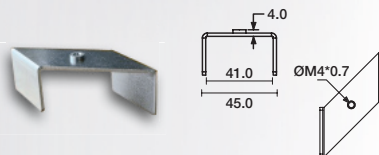

Product Code	EAN	Colour	Package
PRO-R105-001	8719747935569	Alu	30 / 180



TRACK COVER STRIP 3M

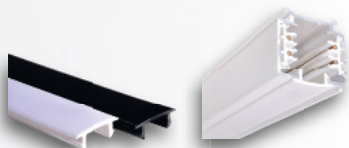

Product Code	EAN	Colour	Package
PRO-CS04300-W	8719747932438	White	1 / 150
PRO-CS04300-B	8719747932445	Black	1 / 150



MECHANICAL ADAPTER



Product Code	EAN	Colour	Package
PRO-0449-W	8719747930908	White	6 / 120
PRO-0449-S	8719747930915	Grey	6 / 120
PRO-0449-B	8719747930922	Black	6 / 120



WALL CLAMP 9 CM



Product Code	EAN	Colour	Package
PRO-04WK-W	8719747935552	□ White	15 / 90
PRO-04WK-S	8719747935262	■ Grey	15 / 90
PRO-04WK-B	8719747934715	■ Black	15 / 90



FIXED MONOPOINT FORTRACK ADAPTER

universal

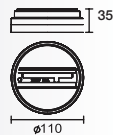

Product Code	EAN	Colour	Package
PRO-C100-W	8719747930960	□ White	1 / 50
PRO-C100-S	8719747930977	■ Grey	1 / 50
PRO-C100-B	8719747930984	■ Black	1 / 50



FIXED MONOPOINT FOR DALI TRACK ADAPTER

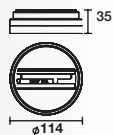

Product Code	EAN	Colour	Package
PRO-C150-W	8719747933213	□ White	1 / 40
PRO-C150-S	8719747933220	■ Grey	1 / 40
PRO-C150-B	8719747933237	■ Black	1 / 40



SCHUKO ADAPTER

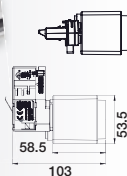

Product Code	EAN	Colour	Package
PRO-4230V-W	8719747930991	□ White	1 / 50
PRO-4230V-B	8719747931004	■ Black	1 / 50





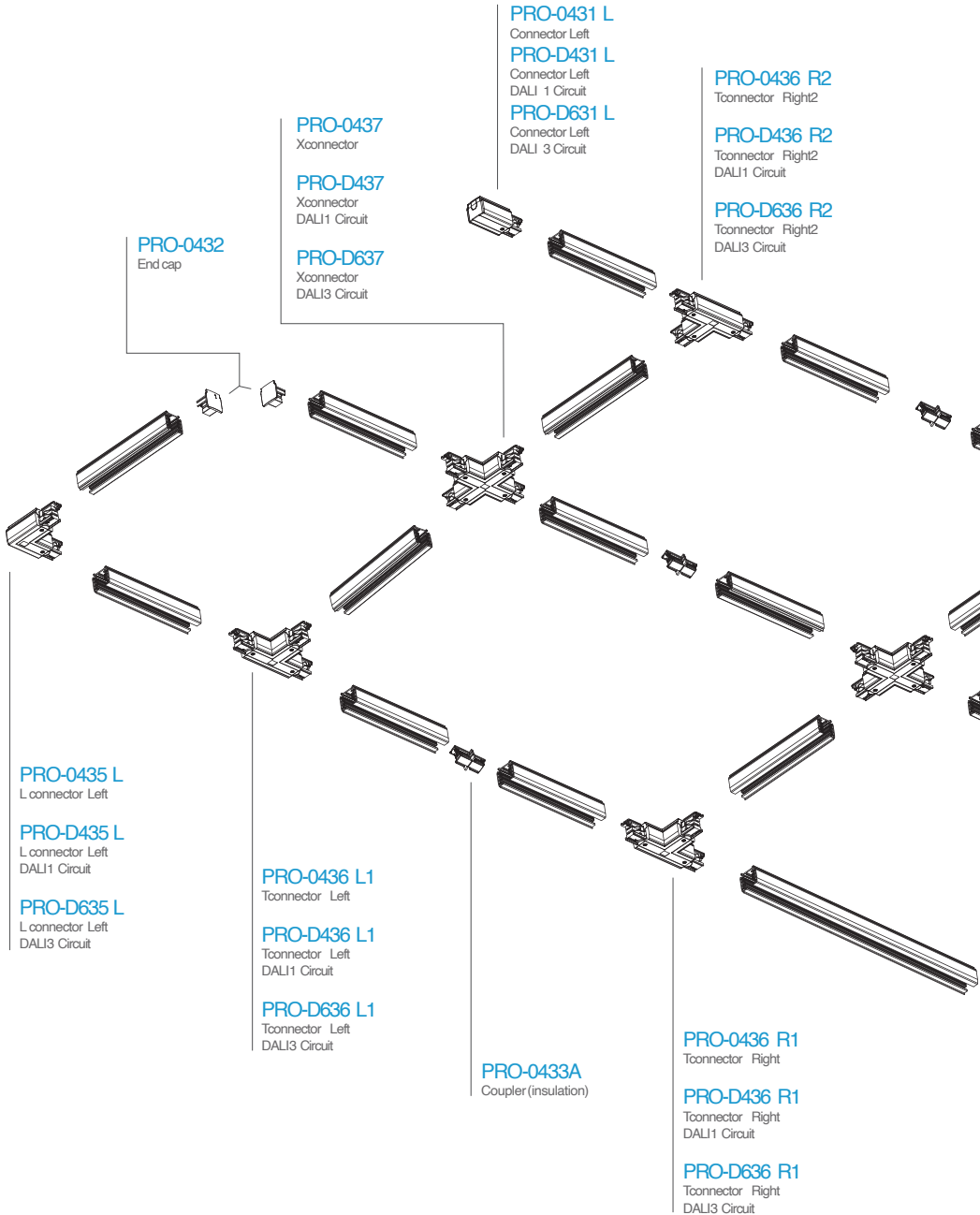

PRO-0432
End cap

PRO-0437
Xconnector

PRO-D437
Xconnector
DALI1 Circuit

PRO-D637
Xconnector
DALI3 Circuit

PRO-0431 L

Connector Left
PRO-D431 L

Connector Left
DALI 1 Circuit

PRO-D631 L

Connector Left
DALI 3 Circuit

PRO-0436 R2
Toconnector Right2

PRO-D436 R2
Toconnector Right2
DALI1 Circuit

PRO-D636 R2
Toconnector Right2
DALI3 Circuit

PRO-0435 L
L connector Left

PRO-D435 L
L connector Left
DALI1 Circuit

PRO-D635 L
L connector Left
DALI3 Circuit

PRO-0436 L1
Toconnector Left

PRO-D436 L1
Toconnector Left
DALI1 Circuit

PRO-D636 L1
Toconnector Left
DALI3 Circuit

PRO-0433A
Coupler (insulation)

PRO-0436 R1
Toconnector Right

PRO-D436 R1
Toconnector Right
DALI1 Circuit

PRO-D636 R1
Toconnector Right
DALI3 Circuit

PRO-0436 L2
Tconnector Left

PRO-D436 L2
Tconnector Left
DALI1 Circuit

PRO-D636 L2
Tconnector Left
DALI3 Circuit

PRO-0431 R
Connector Right

PRO-D431 R
Connector Right
DALI1 Circuit

PRO-D631 R
Connector Right
DALI3 Circuit

PRO-0434
Middle connector

PRO-D434
Middle connector
DALI1 Circuit

PRO-D634
Middle connector
DALI3 Circuit

PRO-0435 R
L connector Right

PRO-D435 R
L connector Right
DALI1 Circuit

PRO-D635 R
L connector Right
DALI3 Circuit

PRO-M435
Adjustable connector

PRO-0433
Coupler
Coupler DALI1 Circuit

PRO-D633
Coupler
DALI3 Circuit

PRO-M435
Adjustable connector

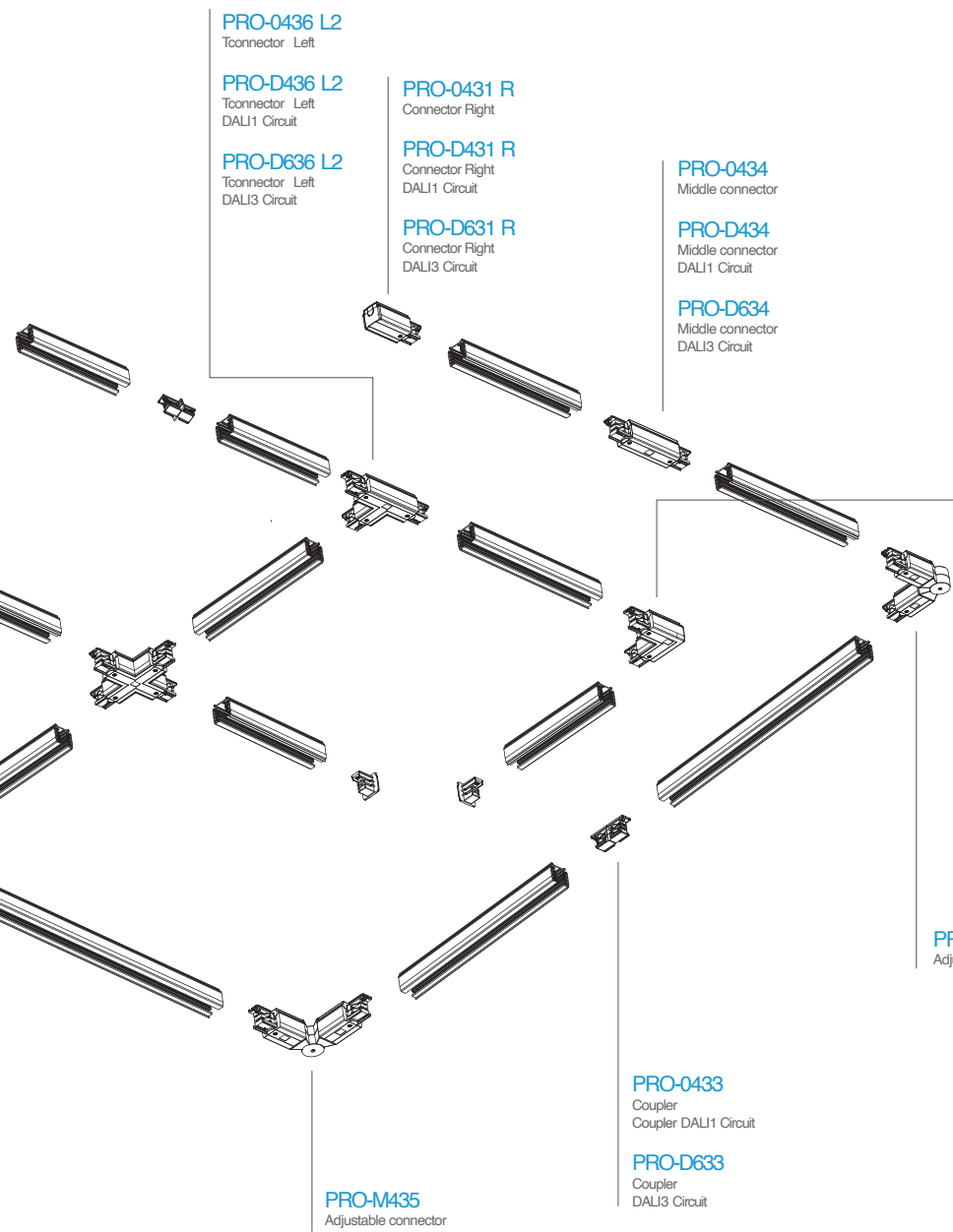

Versatile, innovative
and highly compatible



ADAPTER SOLUTIONS

Powergear offers a wide range of 3 circuit and 3 circuit DALI adapters for the OEM market.

Powergear adapters are highly compatible to all major lighting track systems. The innovative range of intrack adapters

enable new opportunities for minimalistic design in track lights. A multi current LED driver is concealed in the adapter.

To make your 3-circuit system Bluetooth controllable, Powergear offers an Ultimate adapter with Casambi technology.

Product Code	EAN	Colour	Package
PRO-UA420N-W	8719747936566	☐ White	1 / 50
PRO-UA420N-S	8719747936559	■ Grey	1 / 50
PRO-UA420N-B	8719747936542	■ Black	1 / 50
PRO-UA436N-W	8719747936597	☐ White	1 / 50
PRO-UA436N-S	8719747936580	■ Grey	1 / 50
PRO-UA436N-B	8719747936573	■ Black	1 / 50
PRO-UA450N-W	8719747936627	☐ White	1 / 50
PRO-UA450N-S	8719747936610	■ Grey	1 / 50
PRO-UA450N-B	8719747936603	■ Black	1 / 50

Product Code	EAN	Colour	Package
PRO-T61050N-W	8719747934173	☐ White	1 / 50
PRO-T61050N-S	8719747935132	■ Grey	1 / 50
PRO-T61050N-B	8719747935255	■ Black	1 / 50

Product Code	EAN	Colour	Package
PRO-UAD640-W	8719747936795	☐ White	1 / 50
PRO-UAD640-S	8719747936801	■ Grey	1 / 50
PRO-UAD640-B	8719747936788	■ Black	1 / 50

ULTIMATE ADAPTERTUNABLE WHITE



Specifications
 The product supports DALI Dimming
 Output voltage range: 10/40Vdc
 Amplitude dimming 1%...100%
 Low LF-ripple < 5%
 NFC Interface
 Current output: 200-700mA 28W
 Adjustable via Powergear NFCapp

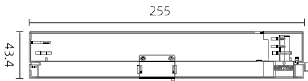

ULTIMATE ADAPTERTUNABLE WHITE



Specifications
 The product supports DALI Dimming
 Output voltage range: 10/40Vdc
 Amplitude dimming 1%...100%
 Low LF-ripple < 5%
 NFC Interface
 Current output: 350-1000mA 40W
 Adjustable via Powergear NFC app

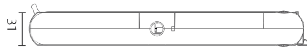
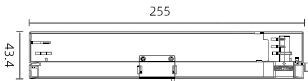

ULTIMATE ADAPTERTRIAC DIMMABLE 200-350MA / 8-14W

DIP Switch



Specifications
 Triac dimming with input voltage 220-240Vac
 Low noise during dimming
 Low LF-ripple < 3%
 Current adjust by DIPSW.

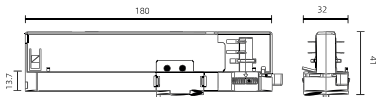

Product Code	EAN	Colour	Package
PRO-UAD625-TW-W	8719747936825	□ White	1 / 50
PRO-UAD625-TW-S	8719747936832	■ Grey	1 / 50
PRO-UAD625-TW-B	8719747936818	■ Black	1 / 50

Product Code	EAN	Colour	Package
PRO-UAD636-TW-W	8719747936856	□ White	1 / 50
PRO-UAD636-TW-S	8719747936863	■ Grey	1 / 50
PRO-UAD636-TW-B	8719747936849	■ Black	1 / 50

Product Code	EAN	Colour	Package
PRO-UAT415S-W	8719747936689	□ White	1 / 50
PRO-UAT415S-S	8719747936696	■ Grey	1 / 50
PRO-UAT415S-B	8719747936672	■ Black	1 / 50

ULTIMATE ADAPTER TRIAC DIMMABLE 500-750mA / 20-30W

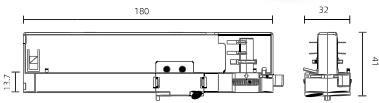

DIPSwitch



Specifications

Triac dimming with input voltage 220-240Vac
Low noise during dimming
Low LF-ripple < 3%
Current adjust by DIPSW.

ULTIMATE ADAPTER

CASAMBI

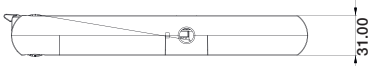

DIPSwitch



Specifications

Flicker Free
Input: 220-240Vac, 50/60Hz
Output: 5-42Vdc, 59Vdc Max.
Current output dc/mA: 325-700mA 14-31W
PF > 0.9, THD < 15%
ta: 0°C - 35°C, tc: 90°C
Fmax: 50N
Unloaded protection, Short-circuit Protection,
Overvoltage Protection
Certificate: ENEC/CE/CCC

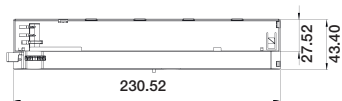

Product Code	EAN	Colour	Package
PRO-UAT430S-W	8719747936719	☐ White	1 / 50
PRO-UAT430S-S	8719747936726	■ Grey	1 / 50
PRO-UAT430S-B	8719747936702	■ Black	1 / 50

Product Code	EAN	Colour	Package
PRO-4700CB-W	8719747934074	☐ White	1 / 50
PRO-4700CB-S	8719747934081	■ Grey	1 / 50
PRO-4700CB-B	8719747934098	■ Black	1 / 50

SMART 3-CIRCUIT ADAPTER



Product Code	EAN	Colour	Package
PRO-0222-W	8719747930182	White	1 / 150
PRO-0222-S	8719747930199	Grey	1 / 150
PRO-0222-B	8719747930205	Black	1 / 150

FMax: 50N

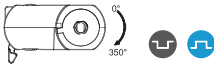

CLASSIC 3-CIRCUIT ADAPTER



Product Code	EAN	Colour	Package
PRO-0440-W	8719747932346	White	1 / 150
PRO-0440-S	8719747932353	Grey	1 / 150
PRO-0440-B	8719747932360	Black	1 / 150

FMax: 100N



NIPPLE M13X12

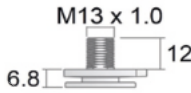

Product Code	EAN	Colour	Package
PRO-M13-012-02	8719747933145	Alu	100

NIPPLE M10X8

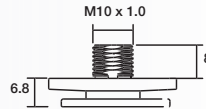

Product Code	EAN	Colour	Package
PRO-M10-008-02	8719747932315	Alu	100
PRO-M10-008-02-W	8719747932513	White	100
PRO-M10-008-02-S	8719747932674	Grey	100
PRO-M10-008-02-B	8719747932520	Black	100

PVC STRAIN RELIEF

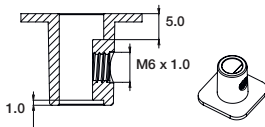

Product Code	EAN	Colour	Package
PRO-M510-W	8719747933244	White	100
PRO-M510-S	8719747933251	Grey	100
PRO-M510-B	8719747933268	Black	100

PVC NIPPLE STRAIN RELIEF M10

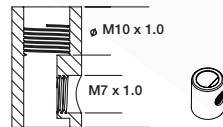

Product Code	EAN	Colour	Package
PRO-M10-008-PVC-W	8719747933152	White	100
PRO-M10-008-PVC-S	8719747933169	Grey	100
PRO-M10-008-PVC-B	8719747933176	Black	100

DALI 3-CIRCUIT ADAPTER



Product Code	EAN	Colour	Package
PRO-D680-W	8719747931349	□ White	1 / 150
PRO-D680-S	8719747931356	■ Grey	1 / 150
PRO-D680-B	8719747931363	■ Black	1 / 150

FMax: 100N

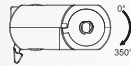

NIPPLE M10X12

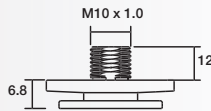

Product Code	EAN	Colour	Package
PRO-M10-012-02	8719747932322	■ Alu	100
PRO-M10-012-02-W	8719747932537	□ White	100
PRO-M10-012-02-S	8719747932681	■ Grey	100
PRO-M10-012-02-B	8719747932544	■ Black	100

SMART 3-CIRCUIT ADAPTER

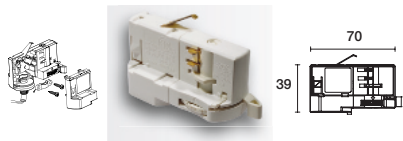

Product Code	EAN	Colour	Package
PRO-0222-W	8719747930182	□ White	1 / 150
PRO-0222-S	8719747930199	■ Grey	1 / 150
PRO-0222-B	8719747930205	■ Black	1 / 150

FMax: 50N

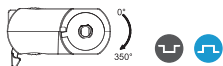

CLASSIC 3-CIRCUIT ADAPTER



Product Code	EAN	Colour	Package
PRO-0440-W	8719747932346	□ White	1 / 150
PRO-0440-S	8719747932353	■ Grey	1 / 150
PRO-0440-B	8719747932360	■ Black	1 / 150

FMax: 100N



DALI 1-CIRCUIT ADAPTER

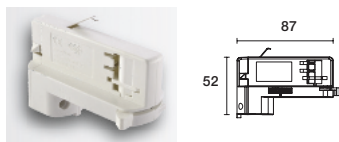

Product Code	EAN	Colour	Package
PRO-D480-W	8719747931851	□ White	1 / 150
PRO-D480-S	8719747931868	■ Grey	1 / 150
PRO-D480-B	8719747931875	■ Black	1 / 150

FMax: 100N



NIPPLE M10X8

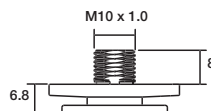

Product Code	EAN	Colour	Package
PRO-M10-008-02	8719747932315	■ Alu	100
PRO-M10-008-02-W	8719747932513	□ White	100
PRO-M10-008-02-S	8719747932674	■ Grey	100
PRO-M10-008-02-B	8719747932520	■ Black	100

PVC STRAIN RELIEF

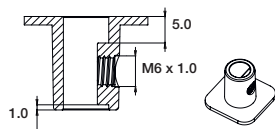

Product Code	EAN	Colour	Package
PRO-M510-W	8719747933244	□ White	100
PRO-M510-S	8719747933251	■ Grey	100
PRO-M510-B	8719747933268	■ Black	100

PVC NIPPLE STRAIN RELIEF M10

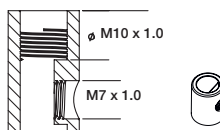

Product Code	EAN	Colour	Package
PRO-M10-008-PVC-W	8719747933152	□ White	100
PRO-M10-008-PVC-S	8719747933169	■ Grey	100
PRO-M10-008-PVC-B	8719747933176	■ Black	100

DALI 3-CIRCUIT ADAPTER



Product Code	EAN	Colour	Package
PRO-D680-W	8719747931349	□ White	1 / 150
PRO-D680-S	8719747931356	■ Grey	1 / 150
PRO-D680-B	8719747931363	■ Black	1 / 150

FMax: 100N

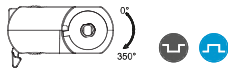

NIPPLE M13X12

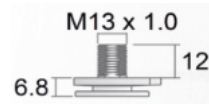

Product Code	EAN	Colour	Package
PRO-M13-012-02	8719747933145	■ Alu	100

NIPPLE M10X12

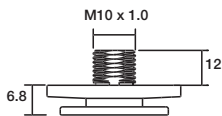

Product Code	EAN	Colour	Package
PRO-M10-012-02	8719747932322	■ Alu	100
PRO-M10-012-02-W	8719747932537	□ White	100
PRO-M10-012-02-S	8719747932681	■ Grey	100
PRO-M10-012-02-B	8719747932544	■ Black	100

TOOL FOR WIRING



Product Code	EAN	Colour	Package
PRO-0222-001-04	8719747932308		1

ULTIMATE ADAPTER DRIVER DESIGNED BY OSRAM



DIPSwitch



Specifications
 Flicker Free, Ripple Free
 Input:220-240Vac,50/60Hz
 Output:25-42Vdc
 Current output dc/mA: Pro-UA420 / 250-500mA11-21W
 Pro-UA430 / 600-800mA25-34W
 Pro-UA440 / 850-1050mA36-44W

Dip-switches for easy output current selection
 Lifetime:50.000 hours
 Fmax: 50N
 Certificate: ENEC/CE/CCC

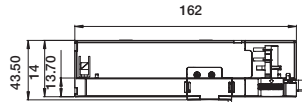
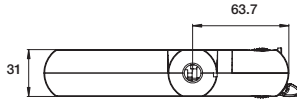
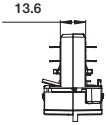

ULTIMATE ADAPTER DALI



DIPSwitch



Specifications
 Flicker Free
 Input:220-240Vac,50/60Hz
 Output: 5-42Vdc, 59Vdc Max.
 Current output dc/mA: 300-1050mA12.6-40W

PF0.97,THD<15%
 ta: 0°C- 35°C, tc: 85°C
 Fmax:100N
 Unloaded protection,Short-circuit Protection,
 Overvoltage Protection
 Certificate: ENEC/CE/CCC

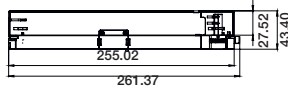
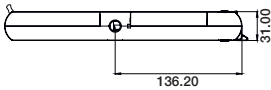

ULTIMATE ADAPTER CASAMBI

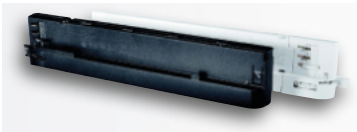

DIPSwitch



Specifications
 Flicker Free
 Input:220-240Vac,50/60Hz
 Output: 5-42Vdc, 59Vdc Max.
 Current output dc/mA:325-700mA14-31W

PF>0.9,THD<15%
 ta: 0°C- 35°C, tc: 90°C
 Fmax: 50N
 Unloaded protection,Short-circuit Protection,
 Overvoltage Protection
 Certificate: ENEC/CE/CCC

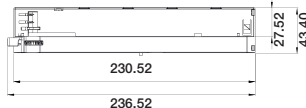
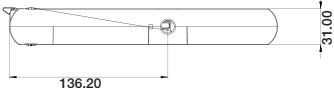

Product Code	EAN	Colour	Package
PRO-UA420-W	8719747933985	☐ White	1 / 50
PRO-UA420-S	8719747933992	■ Grey	1 / 50
PRO-UA420-B	8719747934005	■ Black	1 / 50
PRO-UA430-W	8719747934012	☐ White	1 / 50
PRO-UA430-S	8719747934029	■ Grey	1 / 50
PRO-UA430-B	8719747934036	■ Black	1 / 50
PRO-UA440-W	8719747934043	☐ White	1 / 50
PRO-UA440-S	8719747934050	■ Grey	1 / 50
PRO-UA440-B	8719747934067	■ Black	1 / 50

Product Code	EAN	Colour	Package
PRO-T61050N-W	8719747934173	☐ White	1 / 50
PRO-T61050N-S	8719747935132	■ Grey	1 / 50
PRO-T61050N-B	8719747935255	■ Black	1 / 50

Product Code	EAN	Colour	Package
PRO-4700CB-W	8719747934074	☐ White	1 / 50
PRO-4700CB-S	8719747934081	■ Grey	1 / 50
PRO-4700CB-B	8719747934098	■ Black	1 / 50



The miniaturized alternative,
flexible and elegant

48V TRACK SYSTEM



The high quality Powergear48V lighting track system for the professional lighting market is suitable for track lights with Powergear48V adapters.

Whether for aesthetic or technical reasons e.g. in residential, high end retail or museum projects, Powergear's 48V lighting track system is ideal in cases where subtle designs are required.

A comprehensive range of innovative accessories and a multitude of different ultimate adapters, give designers maximum freedom to create unique and smart 48V lighting track plans.

Powergear48V lighting track systems come in various surface mounted as well as recessed versions. The "EZCLICK" mounting features complete the system and make the track system quick and easy to install for suspended solutions.

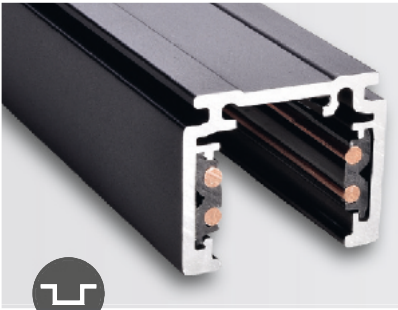

SURFACE MOUNTED

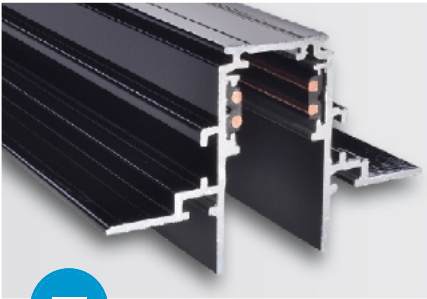
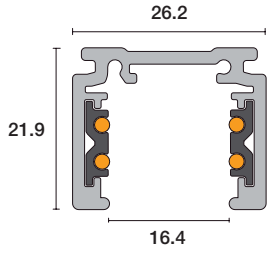

RECESSED

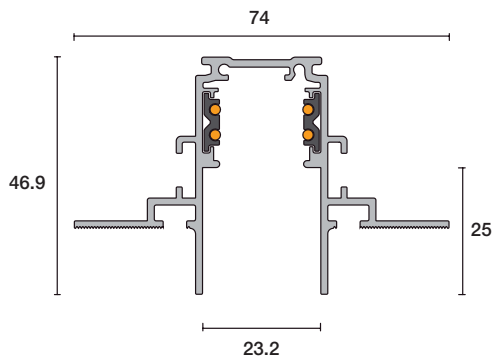

SURFACE MOUNTED

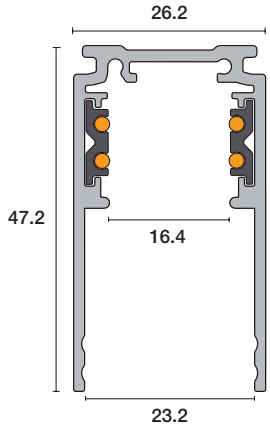

More technical details on page 43.

48V SURFACE MOUNTED TRACK SYSTEM

Product Code	EAN	Product description	Colour	Package
PRO-N110-B-PT	8719747934135	1 M track (1000mm)	■ Black	1 / 9
PRO-N120-B-PT	8719747934142	2 M track (2000mm)	■ Black	1 / 9
PRO-N130-B-PT	8719747934159	3 M track (3000mm)	■ Black	1 / 9
PRO-N110-W-PT	8719747934760	1 M track (1000mm)	□ White	1 / 9
PRO-N120-W-PT	8719747934777	2 M track (2000mm)	□ White	1 / 9
PRO-N130-W-PT	8719747934784	3 M track (3000mm)	□ White	1 / 9

48V RECESSED TRACK SYSTEM

Product Code	EAN	Product description	Colour	Package
PRO-RN110-B-PT	8719747934586	1 M track (1000mm)	■ Black	1 / 4
PRO-RN120-B-PT	8719747934593	2 M track (2000mm)	■ Black	1 / 4
PRO-RN130-B-PT	8719747934609	3 M track (3000mm)	■ Black	1 / 4
PRO-RN110-W-PT	8719747934791	1 M track (1000mm)	□ White	1 / 4
PRO-RN120-W-PT	8719747934807	2 M track (2000mm)	□ White	1 / 4
PRO-RN130-W-PT	8719747934814	3 M track (3000mm)	□ White	1 / 4

48V SURFACE MOUNTED DEEP TRACK SYSTEM

Product Code	EAN	Product description	Colour	Package
PRO-DN110-B-PT	8719747934821	1 M track (1000mm)	■ Black	1 / 9
PRO-DN120-B-PT	8719747934838	2 M track (2000mm)	■ Black	1 / 6
PRO-DN130-B-PT	8719747934845	3 M track (3000mm)	■ Black	1 / 6
PRO-DN110-W-PT	8719747934852	1 M track (1000mm)	□ White	1 / 9
PRO-DN120-W-PT	8719747934869	2 M track (2000mm)	□ White	1 / 6
PRO-DN130-W-PT	8719747934876	3 M track (3000mm)	□ White	1 / 6

LIVE END CONNECTOR LEFT

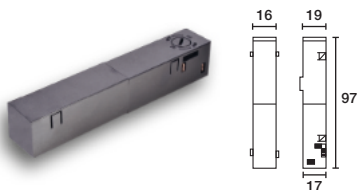

Product Code	EAN	Colour	Package
PRO-N131L-B	8719747934166	■ Black	10 / 200
PRO-N131L-W	8719747934883	□ White	10 / 200



LIVE END CONNECTOR RIGHT

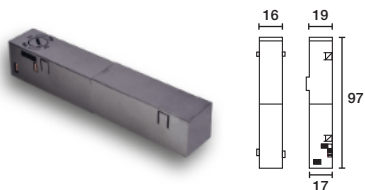

Product Code	EAN	Colour	Package
PRO-N131R-B	8719747934906	■ Black	10 / 200
PRO-N131R-W	8719747934913	□ White	10 / 200



END CAP



Product Code	EAN	Colour	Package
PRO-N132-B	8719747934180	■ Black	50 / 1000
PRO-N132-W	8719747934982	□ White	50 / 1000



RECESSED END CAP

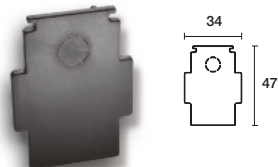

Product Code	EAN	Colour	Package
PRO-RN132-B	8719747934197	■ Black	50 / 1000
PRO-RN132-W	8719747934999	□ White	50 / 1000



I CONNECTOR

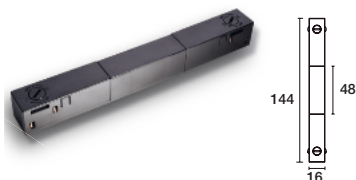

Product Code	EAN	Colour	Package
PRO-N133-B	8719747934210	■ Black	15 / 300
PRO-N133-W	8719747935033	□ White	15 / 300



L CONNECTOR



Product Code	EAN	Colour	Package
PRO-N135-B	8719747934227	■ Black	20 / 100
PRO-N135-W	8719747935040	□ White	20 / 100



LIVE END CONNECTOR WITH END CAP LEFT



Product Code	EAN	Colour	Package
PRO-N131LX-B	8719747935941	■ Black	N/A
PRO-N131LX-W	8719747935958	□ White	N/A



LIVE END CONNECTOR WITH END CAP RIGHT



Product Code	EAN	Colour	Package
PRO-N131RX-B	8719747935965	■ Black	N/A
PRO-N131RX-W	8719747935972	□ White	N/A



DEEP PROFILE END CAP

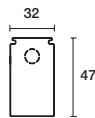

Product Code	EAN	Colour	Package
PRO-DN132-B	8719747935002	■ Black	50 / 1000
PRO-DN132-W	8719747935019	□ White	50 / 1000



FLEXIBLE CONNECTOR



Product Code	EAN	Colour	Package
PRO-N139-B	8719747934203	■ Black	20 / 100
PRO-N139-W	8719747935026	□ White	20 / 100



L PROFILE CONNECTOR-FLAT LEFT

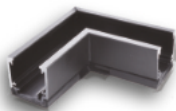

Product Code	EAN	Colour	Package
PRO-N135FL-B	8719747934234	■ Black	12 / 96
PRO-N135FL-W	8719747935057	□ White	12 / 96



L PROFILE CONNECTOR-FLAT RIGHT

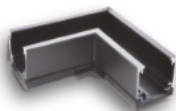

Product Code	EAN	Colour	Package
PRO-N135FR-B	8719747935453	■ Black	12 / 96
PRO-N135FR-W	8719747935460	□ White	12 / 96



L DEEP PROFILE CONNECTOR-FLAT LEFT

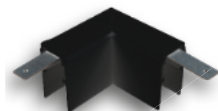

Product Code	EAN	Colour	Package
PRO-DN135FL-B	8719747935491	■ Black	6 / 80
PRO-DN135FL-W	8719747935507	□ White	6 / 80



L DEEP PROFILE CONNECTOR-FLAT RIGHT

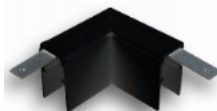

Product Code	EAN	Colour	Package
PRO-DN135FR-B	8719747935514	■ Black	6 / 80
PRO-DN135FR-W	8719747935521	□ White	6 / 80



L DEEP PROFILE CONNECTOR-STEREO

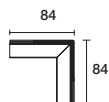
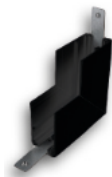

Product Code	EAN	Colour	Package
PRO-DN135S-B	8719747935538	■ Black	8 / 96
PRO-DN135S-W	8719747935545	□ White	8 / 96



CEILING MOUNT EZ CLICK WITH ROD 1M



Product Code	EAN	Colour	Package
PRO-EZN147-B	8719747934326	■ Black	12 / 144
PRO-EZN147-W	8719747935095	□ White	12 / 144



L RECESSED PROFILE CONNECTOR-FLAT LEFT

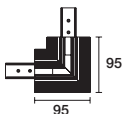
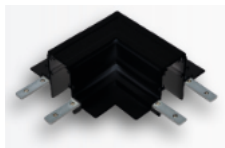

Product Code	EAN	Colour	Package
PRO-RN135FL-B	8719747934291	■ Black	1 / 20
PRO-RN135FL-W	8719747935064	□ White	1 / 20



L RECESSED PROFILE CONNECTOR-FLAT RIGHT

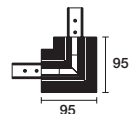
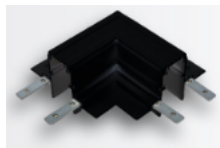

Product Code	EAN	Colour	Package
PRO-RN135FR-B	8719747935477	■ Black	1 / 20
PRO-RN135FR-W	8719747935484	□ White	1 / 20



L PROFILE CONNECTOR-STEREO

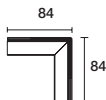
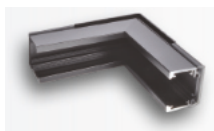

Product Code	EAN	Colour	Package
PRO-N135S-B	8719747934258	■ Black	12 / 96
PRO-N135S-W	8719747935071	□ White	12 / 96



L RECESSED PROFILE CONNECTOR-STEREO



Product Code	EAN	Colour	Package
PRO-RN135S-B	8719747934265	■ Black	1 / 20
PRO-RN135S-W	8719747935088	□ White	1 / 20



CEILING MOUNT EZ CLICK WITH WIRE 3M



Product Code	EAN	Colour	Package
PRO-EZN148-B	8719747934333	■ Black	30
PRO-EZN148-W	8719747935101	□ White	30



CEILING MOUNT REINFORCEMENT WITH ROD 1M

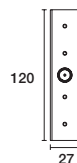

Product Code	EAN	Colour	Package
PRO-N147-B	8719747934364	■ Black	30
PRO-N147-W	8719747935118	□ White	30



CEILING MOUNT REINFORCEMENT WITH WIRE 3M

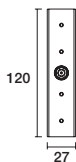

Product Code	EAN	Colour	Package
PRO-N148-B	8719747934371	■ Black	10 / 60
PRO-N148-W	8719747935125	□ White	10 / 60



MOUNTING CLAMP

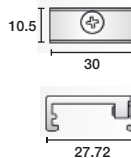

Product Code	EAN	Colour	Package
PRO-N1SK-B	8719747935675	■ Black	20 / 400
PRO-N1SK-W	8719747934319	□ White	20 / 400



TRACK COVER STRIP 2M

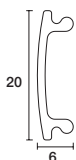
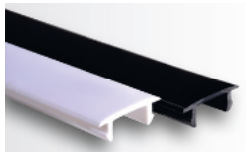

Product Code	EAN	Colour	Package
PRO-CSN20-B	8719747934395	■ Black	50
PRO-CSN20-W	8719747935149	□ White	50



SUSPENSION SET WITH CLAMP



Product Code	EAN	Colour	Package
PRO-N149-B	8719747935927	■ Black	N/A
PRO-N149-W	8719747935934	□ White	N/A



METAL PLATE FOR MAGNETIC SPOTS 880MM

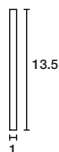
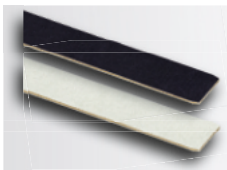

Product Code	EAN	Colour	Package
PRO-MTL100-B	8719747935583	■ Black	100
PRO-MTL100-W	8719747935590	□ White	100





48V ULTIMATE ADAPTERS WITH MECHANICAL LOCK

48V ADAPTER EXCLUDING LED DRIVER / DOUBLE HEAD POLARIZED



PRO-N140A

PRO-N140B

48V ADAPTER INCLUDING ON/OFF LED DRIVER / DOUBLE HEAD POLARIZED



PRO-N140A-OO

PRO-N140B-OO

48V ADAPTER INCLUDING DIMMABLE 0-10V LED DRIVER POLARIZED

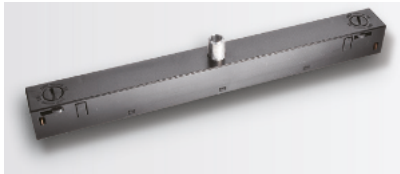

Specifications

Adapter including dimmable 0-10VLEDdriver
 Output: 6-40V
 Current output DC/mA:250-1000mA
 Dip-switches for easy output current selection
 Lifetime: 50.000 hours
 Fmax: 10N

DIPSwitch



Product Code	EAN
PRO-N140A 010V-B	8719747935217
PRO-N140A010V-W	8719747935224

Colour	Package
<input checked="" type="checkbox"/> Black	15 /180
<input type="checkbox"/> White	15 /180

48V ADAPTER INCLUDING DIMMABLE DALI LED DRIVER POLARIZED



Specifications

Adapter including dimmable DALI LEDdriver
 Output: 3-40V
 Current output DC/mA:350-500-700mA
 Dip-switches for easy output current selection
 Lifetime: 50.000 hours
 Fmax: 10N

DIPSwitch



Product Code	EAN	Colour	Package
350mA current output dc			
PRO-N140A-D350-B	8719747935231	<input checked="" type="checkbox"/> Black	15 /180
PRO-N140A-D350-W	8719747935248	<input type="checkbox"/> White	15 /180
500mA current output dc			
PRO-N140A-D500-B	8719747935354	<input checked="" type="checkbox"/> Black	15 /180
PRO-N140A-D500-W	8719747935361	<input type="checkbox"/> White	15 /180
700mA current output dc			
PRO-N140A-D700-B	8719747935378	<input checked="" type="checkbox"/> Black	15 /180
PRO-N140A-D700-W	8719747935385	<input type="checkbox"/> White	15 /180

Specifications

Fmax: 10N

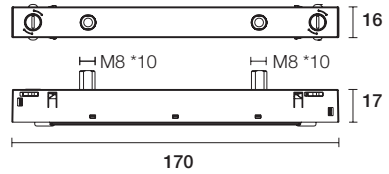
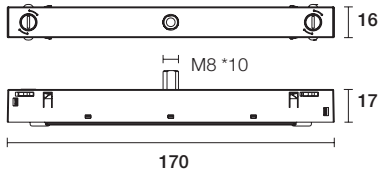

Specifications

Adapter including on/off LEDdriver

Output: 6-40V

Current output DC/mA:250-1000mA

Dip-switches for easy output current selection

Lifetime: 50.000 hours

Fmax: 10N

DIPSwitch



Product Code	EAN	Colour	Package
PRO-N140A-B	8719747934272	■ Black	15 /180
PRO-N140A-W	8719747935156	□ White	15 /180

PRO-N140A-B	8719747934388	■ Black	15 /180
PRO-N140A-W	8719747935163	□ White	15 /180

Product Code	EAN	Colour	Package
PRO-N140A-OO-B	8719747935170	■ Black	15 /180
PRO-N140A-OO-W	8719747935187	□ White	15 /180

PRO-N140B-OO-B	8719747935194	■ Black	15 /180
PRO-N140B-OO-W	8719747935200	□ White	15 /180

MECHANICAL LOAD DIAGRAM

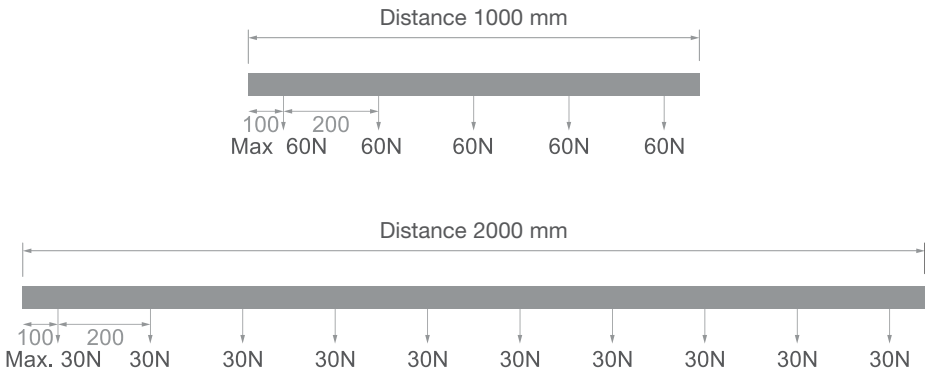

FIXING POINT DIMENSIONS

L / mm	a / mm	b / mm	c / mm	d / mm
1000	125			
2000	125	998		
3000	125		914	1167

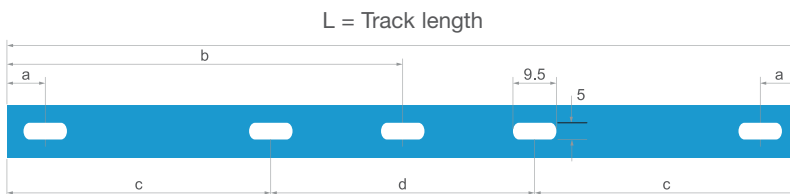

It is recommended to fasten the track at every hole with a screw or suspension kit.

CONNECTING DIAGRAM

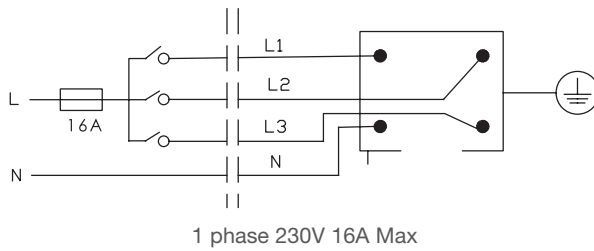
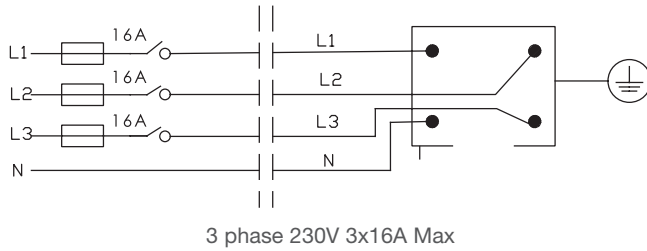

CONNECTING DIAGRAM (RED LINE INDICATES THE POLARITY RIDGE.)

FLOOR VIEW

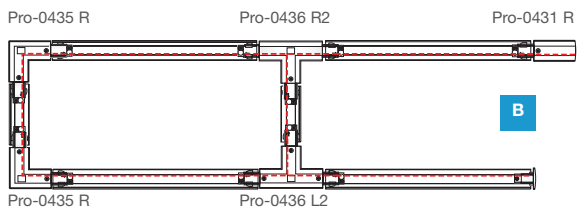
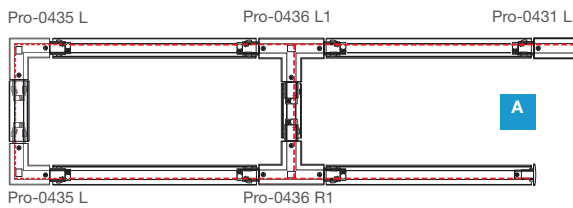

MECHANICAL LOAD DIAGRAM

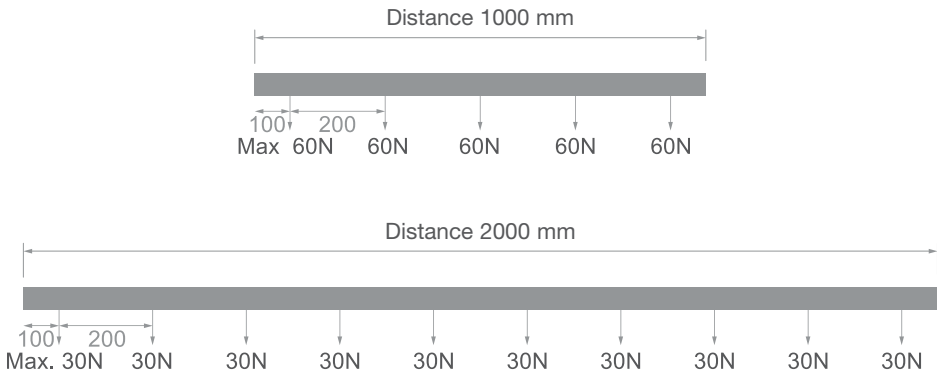

FIXING POINT DIMENSIONS

L / mm	a / mm	b / mm	c / mm	d / mm
1000	125			
2000	125	998		
3000	125		914	1167

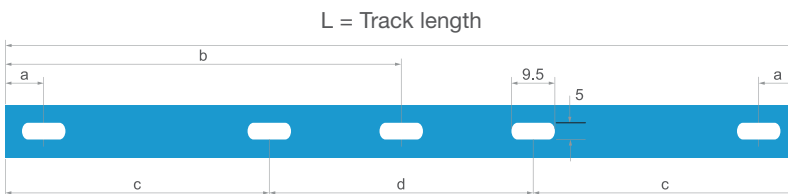

It is recommended to fasten the track at every hole with a screw or suspension kit.

CONNECTING DIAGRAM

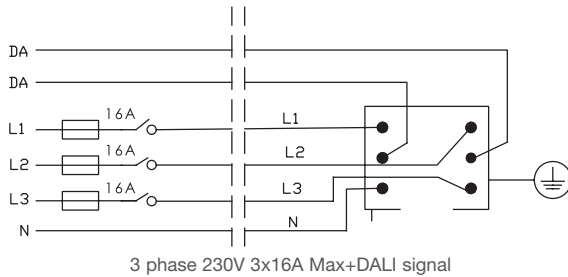
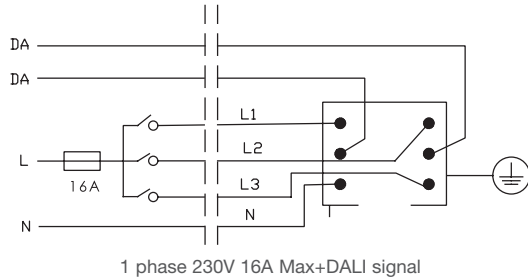

CONNECTING DIAGRAM (RED LINE INDICATES THE POLARITY RIDGE.)

FLOOR VIEW

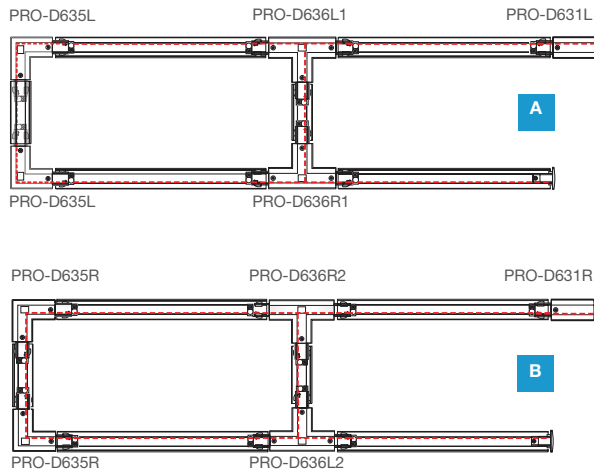

MECHANICAL LOAD DIAGRAM

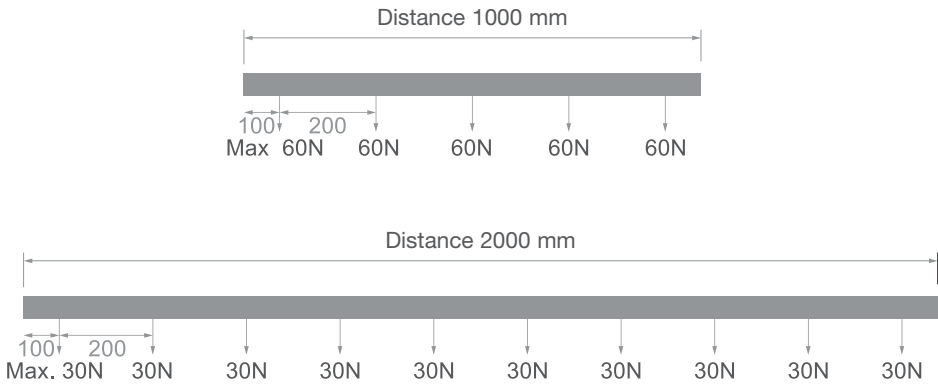

FIXING POINT DIMENSIONS

L / mm	a / mm	b / mm	c / mm	d / mm
1000	125			
2000	125	998		
3000	125		914	1167

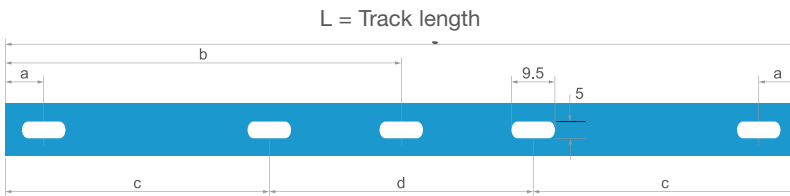

It is recommended to fasten the track at every hole with a screw or suspension kit.

CONNECTING DIAGRAM

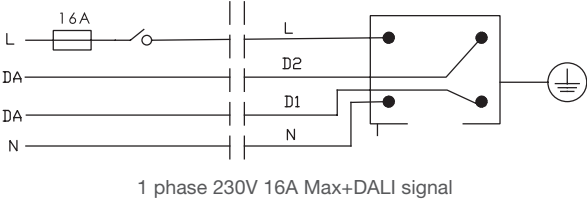

CONNECTING DIAGRAM (RED LINE INDICATES THE POLARITY RIDGE.)

FLOOR VIEW

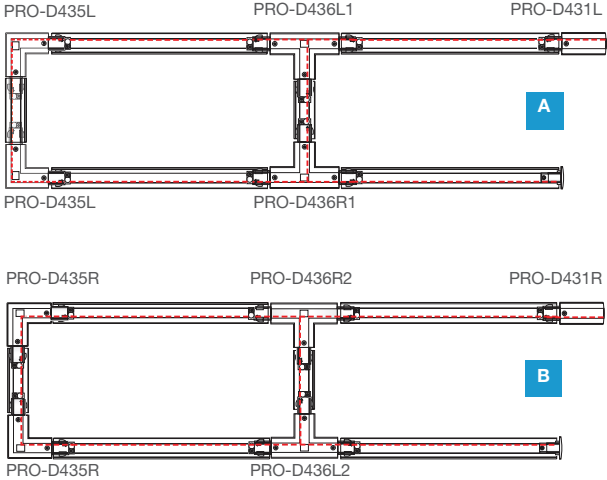

Low Voltage Single Circuit DALI



48V 15A Max.

Low Voltage 2 Circuits



48V 2*15A Max.

T-BAR EZCLICK

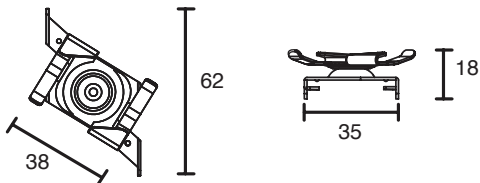
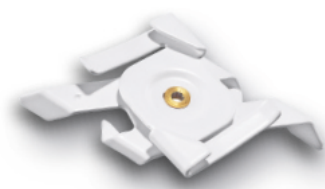

T-BAR EZCLICK MOUNTING INSTRUCTION

- 1 Adjust the EZCLICKMounting Kit's direction, put it vertically on to the T-Bar ceiling, and then rotate right and fix (as picture shows).

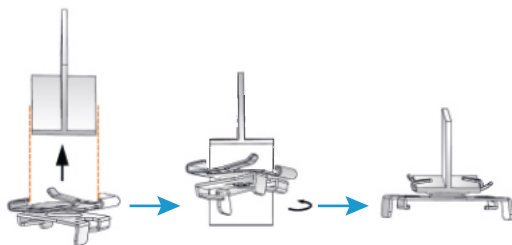

- 2 Adjust the EZCLICKMounting Kit's direction, put the track vertically into the EZCLICKMounting Kit, rotate left and fix (as picture shows)

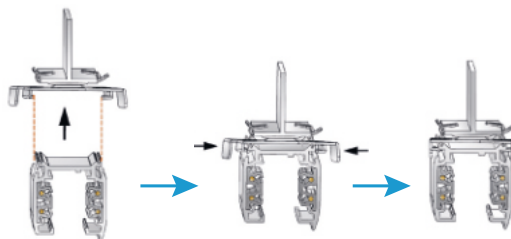

REINFORCEMENT PLATE REINFORCEMENT PLATE WITH 5M STEEL SUSPENSION WIRE



REINFORCEMENT PLATE MOUNTING INSTRUCTION

- 1 Put the track into the reinforcement plate parallel (as picture shows)

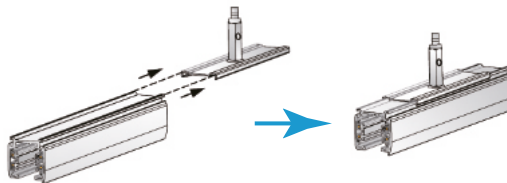

- 2 Release the start valve, press and get the wire through the EZCLICK mounting kit, rotate tight the start valve and lock the wirerope (as picture shows)

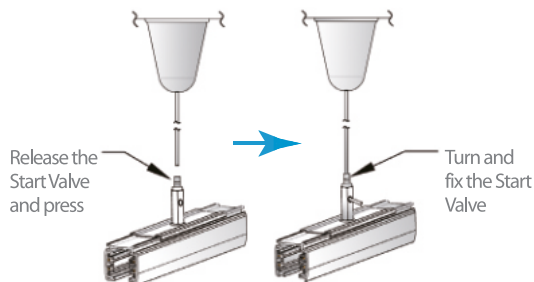



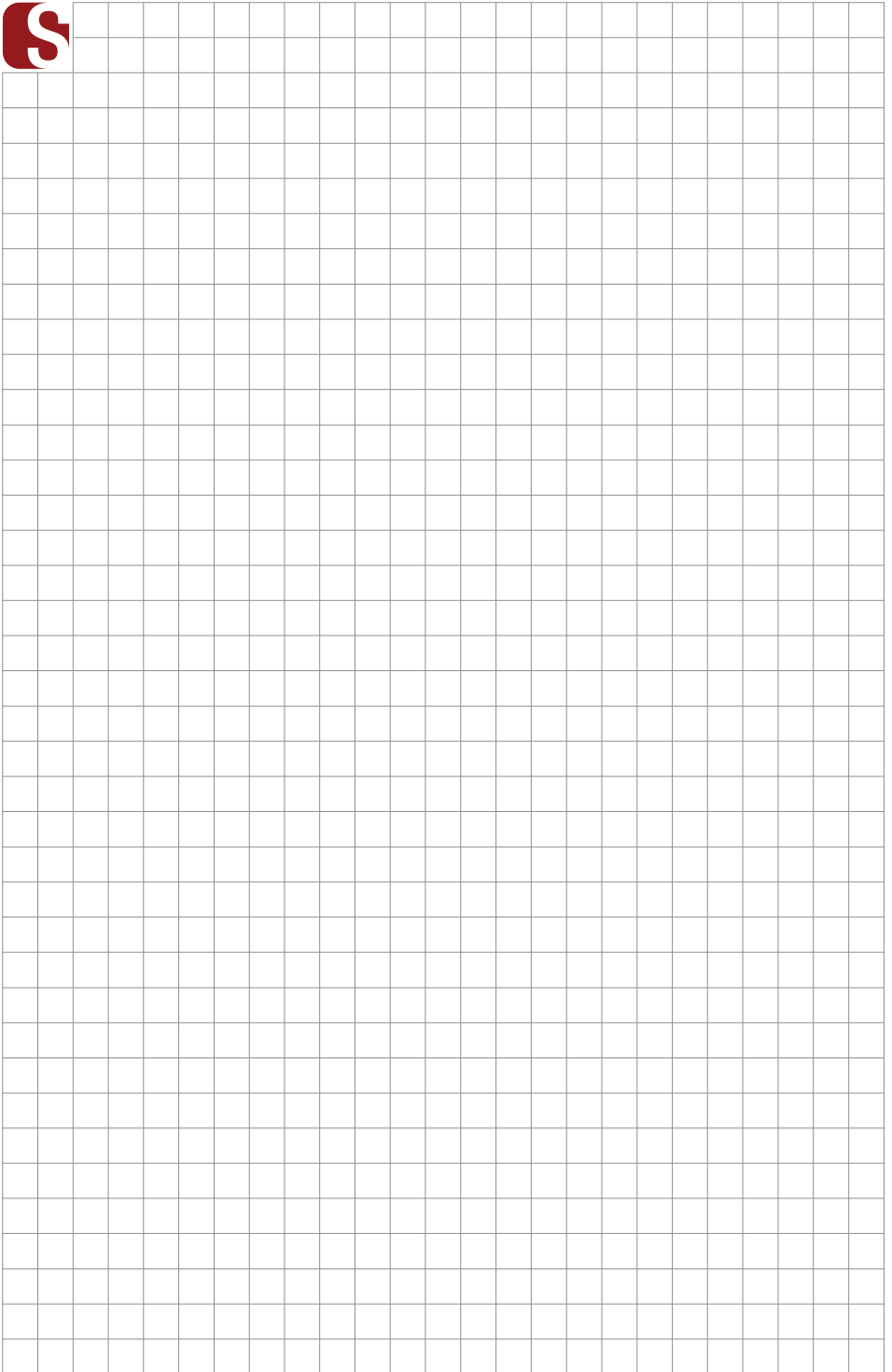

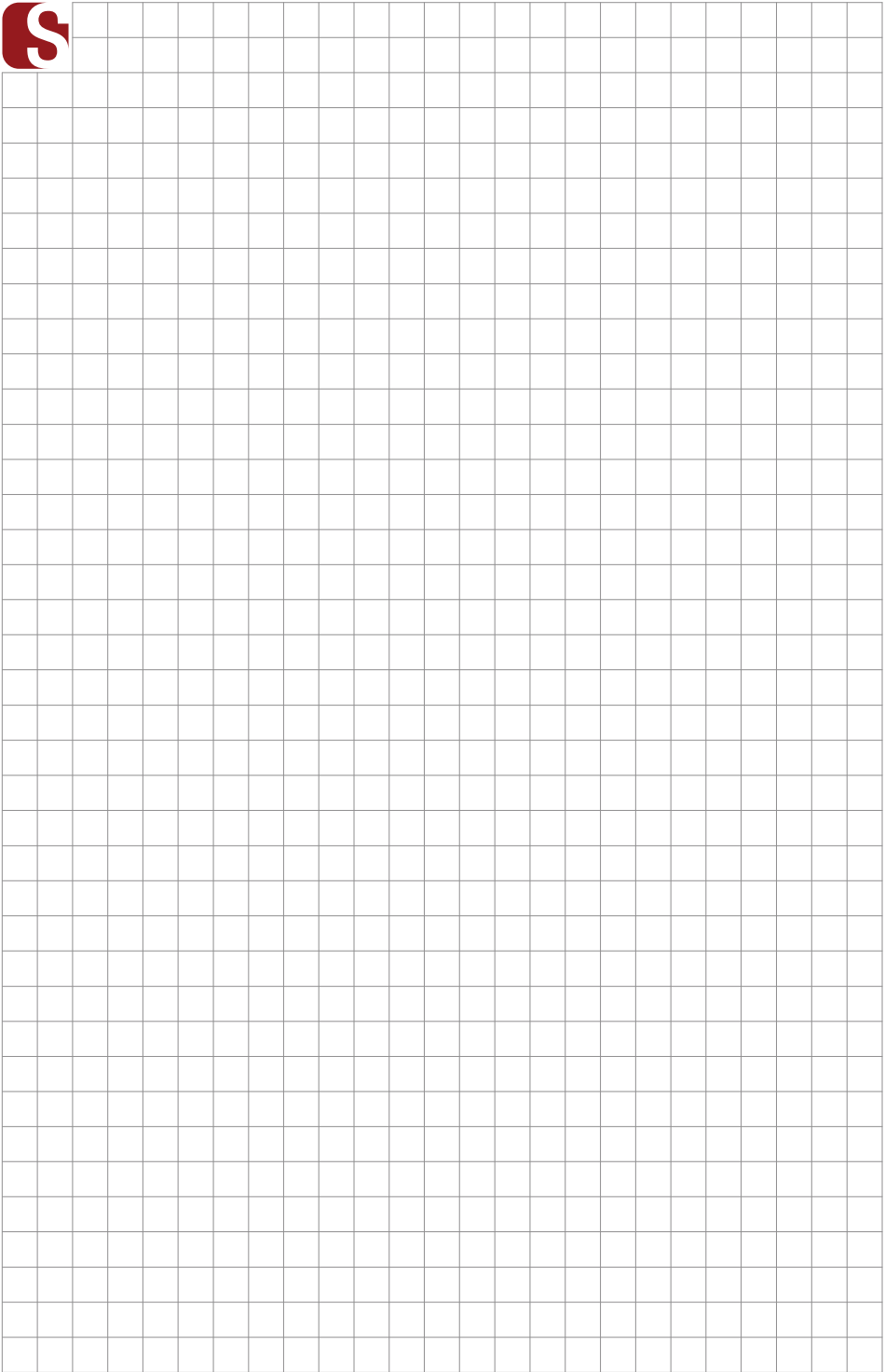

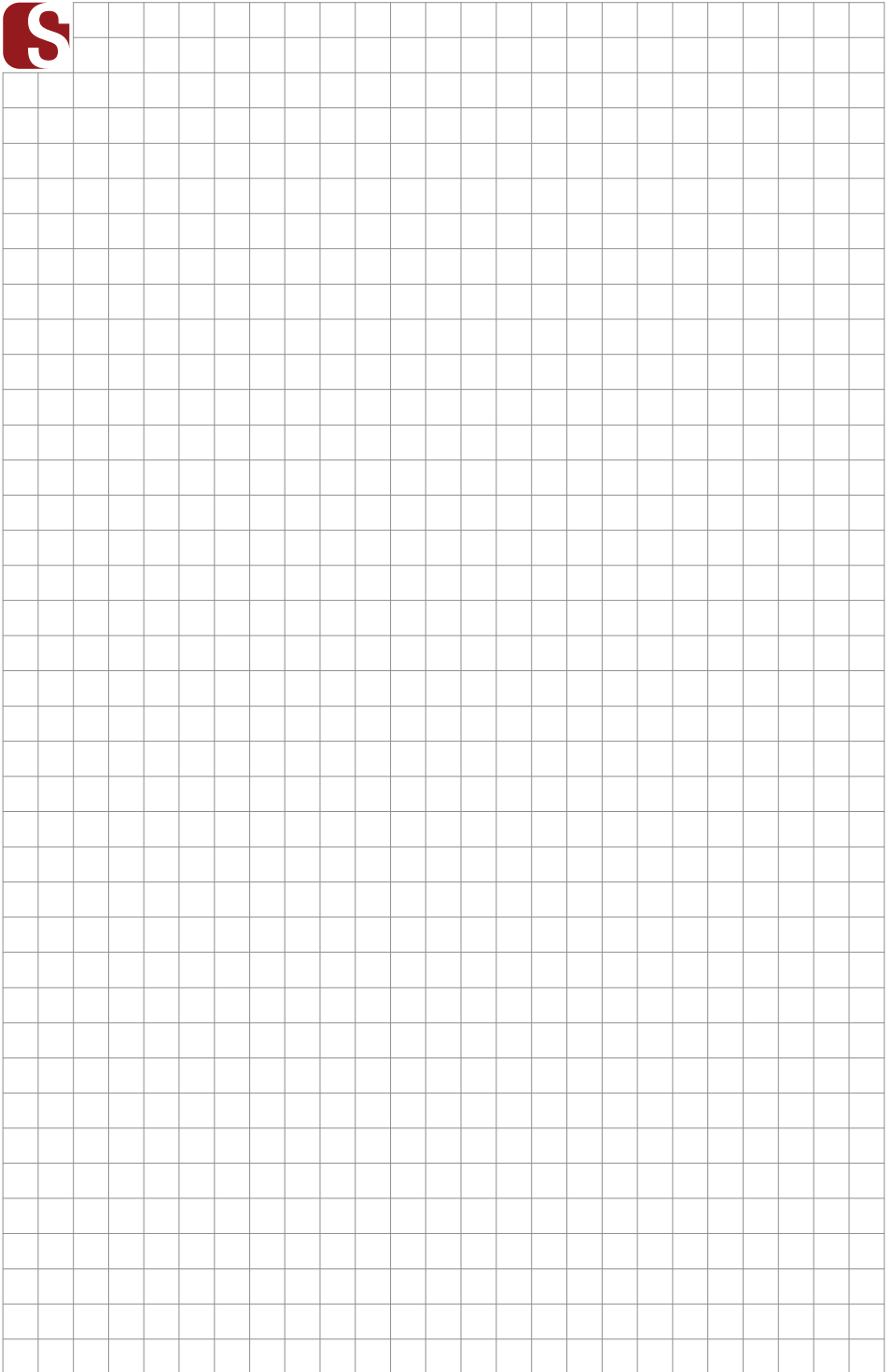

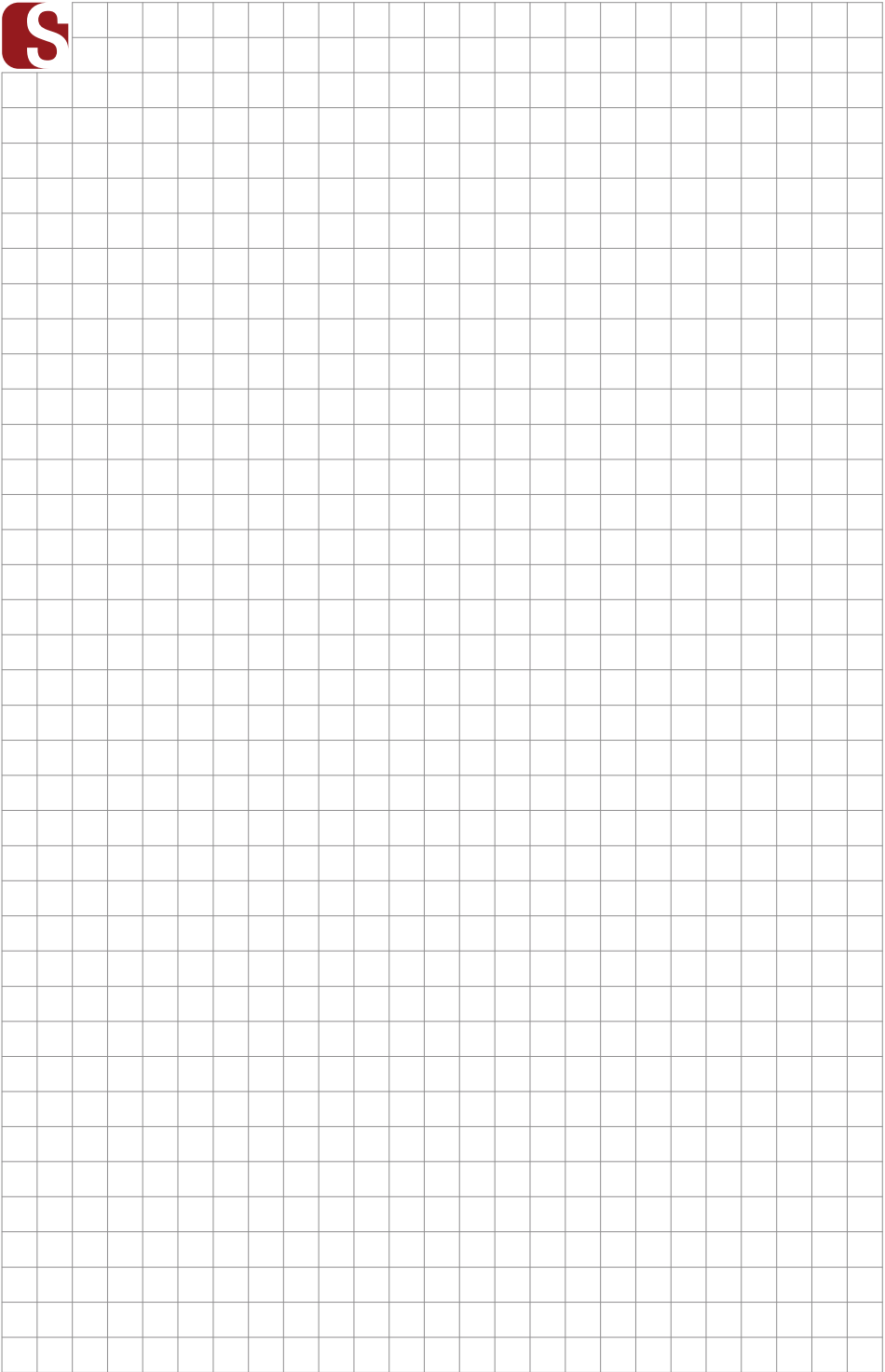

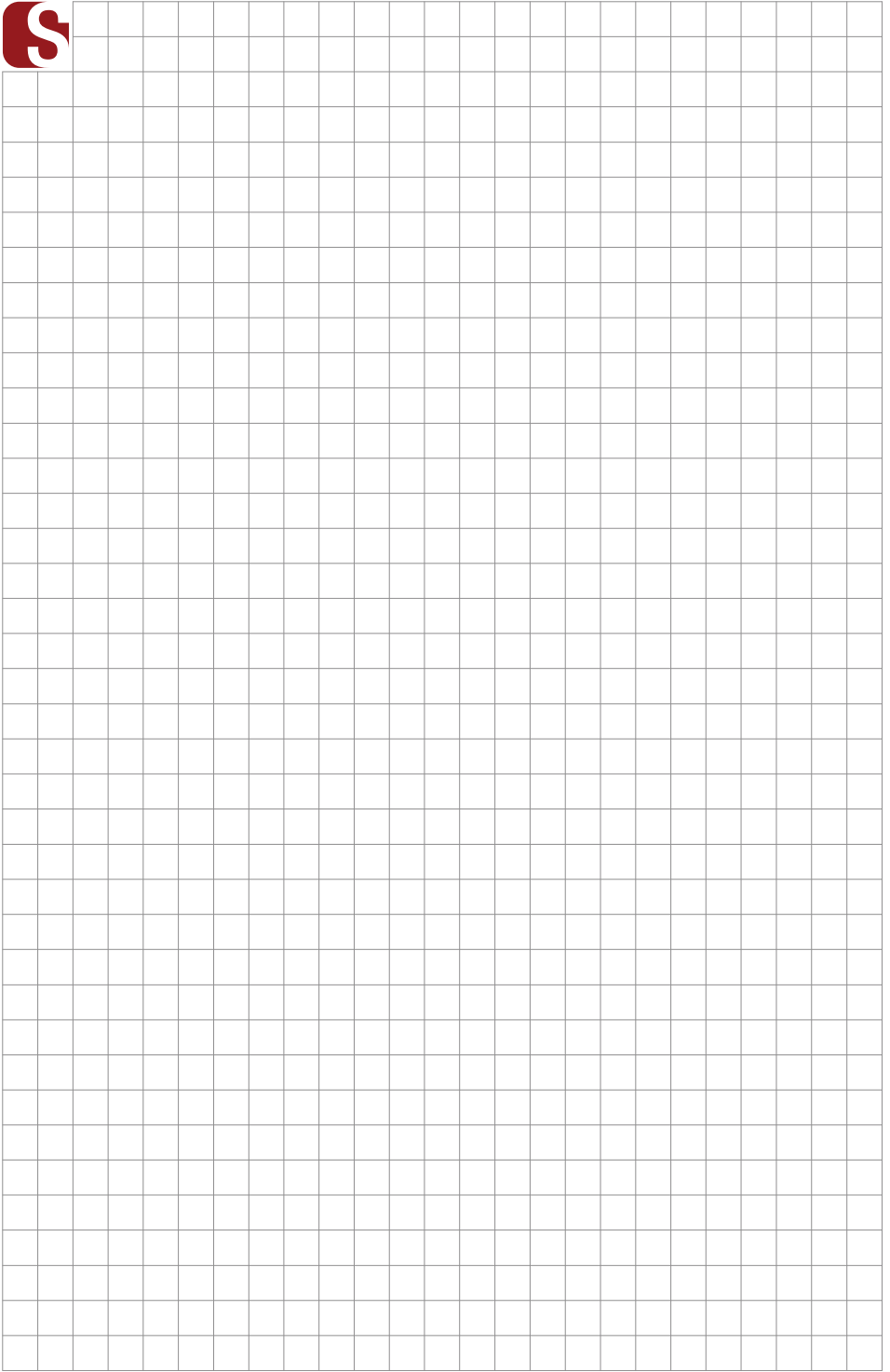

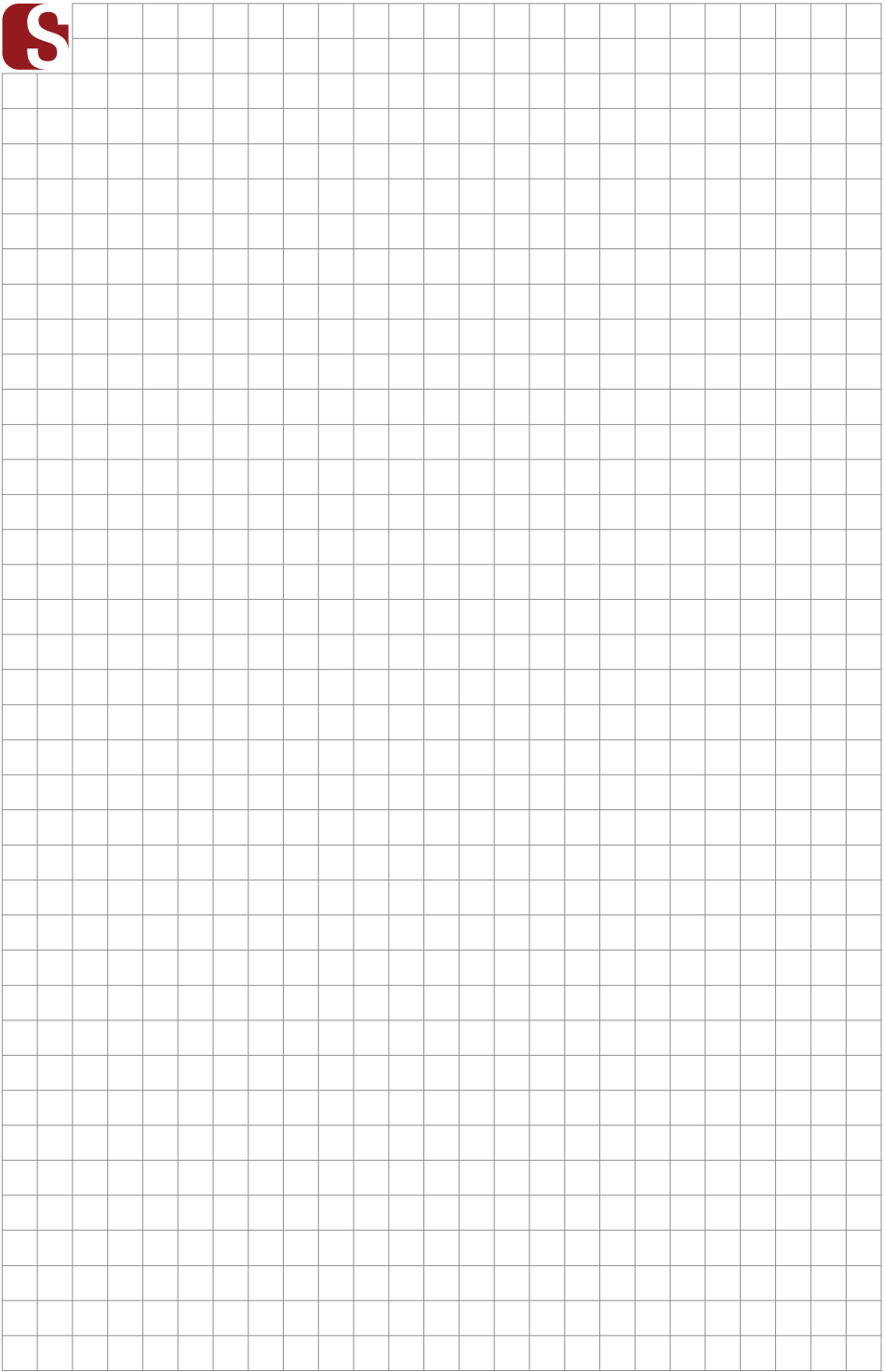

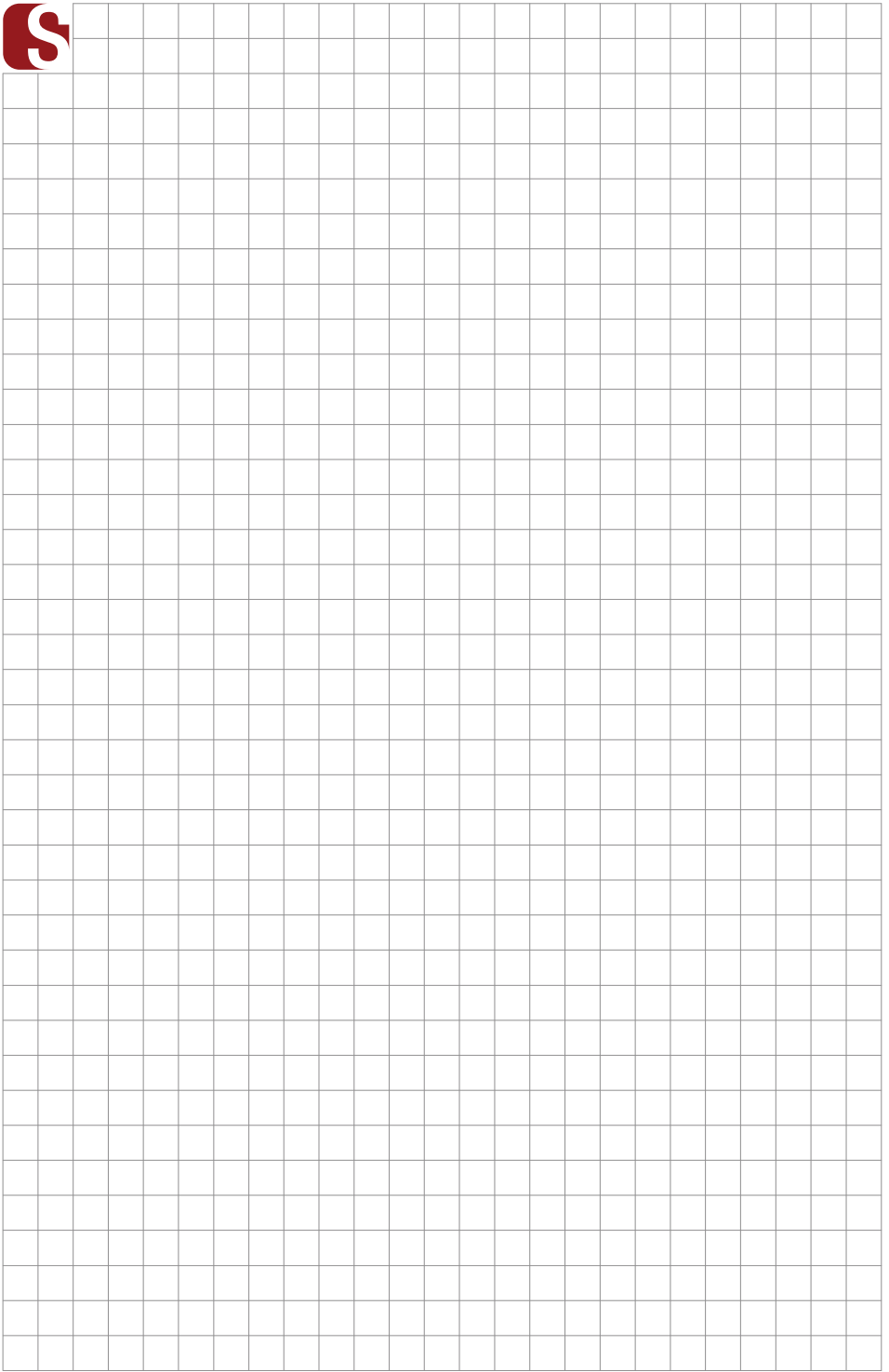

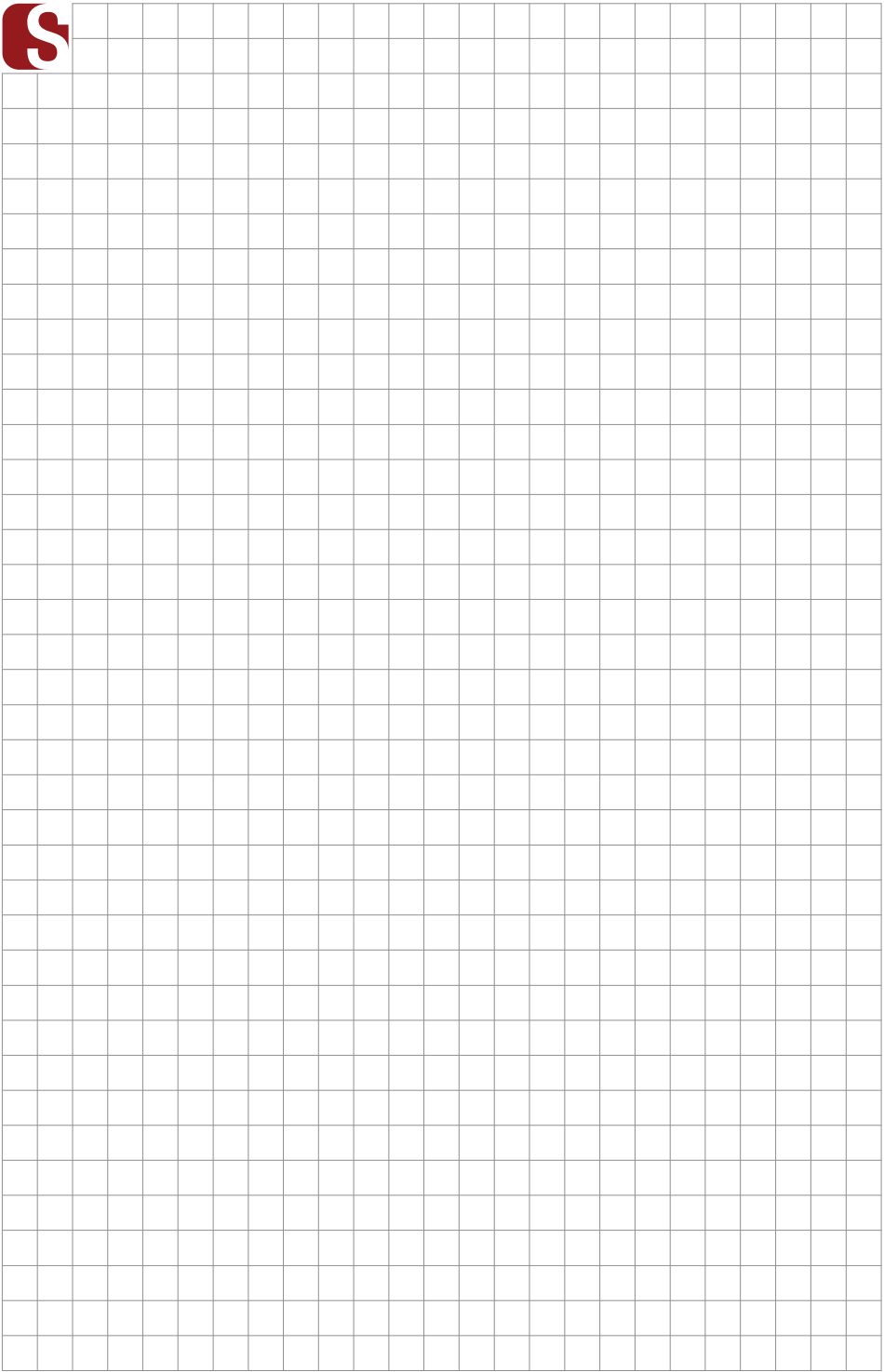



SLIGHT®

Chemin de la Veyre d'en haut D2

1806 St-Légier — Switzerland

+41 21 925 38 88

www.slight.ch

info@slight.ch